



all stores • ls 752 • issued: April 1, 2010

METROPAK

ACCESSORIES

summer I

TABLE OF CONTENTS

2 Table of Contents

2 What's New?

- Summer is here (Floorset Vision)
- Introducing MetroPack redesign

3 Maps

- Side by Side
- 3Door

5 Drive Aisle & Display Wall

- Drive Aisle Table 1- Pieced Tile Collection & Lucite Jewelry
- Drive Aisle Table 2- Marrakech Collection & Key Item Jewelry
- Drive Aisle Table 3- Hardware Stud Collection
- Display Wall - Front Pocket Hobo & Scarf Collection

9 Zone 1

- Table presentation- Zig Zag Straw Tote Lifestyle
- Cabinet presentation-Zig Zag Straw Tote, Sandals, & Belts

11 Zone 2

- a) Table presentation- Twisted Strap Hobo & Casablanca Jewelry
- b) Cabinet presentation- Beaded Tote, Beaded Sandals & Beaded Jewelry

13 Zone 3

- Table presentation- Classic Signature & Flower Applique Signature
- Cabinet presentation- Black Jaquard Signature

15 Zone 4

- SALE

17 Additional

- Accessory Wrap Desk
- Additional Cabinets Zone 1 & 3
- 3 Door Table

21 Fixtures

- Belts (accessory store only)
- Jewelry Fixtures (accessory store only)
- Fixture Maps (3Door & Chain)
- Chain 22" Fixtures

41 Chain Map

42 Drive Aisle Chain Table - Marrakech Collection & Key Item Jewelry

34 Wrap Desk Walls

- Left - Wear To Work Snake Collection
- Right - Key Item Hardware Handbag & Scarves

35 Large Wall - Classic Signature & Fashion Signature

NOTES TO REMEMBER

What's New?

Celebrate Summer with New York & Company's Newest Accessory Collections. Take an imaginary journey to Morocco, and discover our New Casablanca and Marrakech collections. Beaded Handbags, Tribal Jewelry, vivid colors and intricate textures all inspired by the magic of Morocco. Besides offering the hottest trends this season, at our prices it is an irresistible deal. With dresses harmonized to match these must have accessory pieces NYCo is a one stop shop to complete your summer wardrobe. If the heat of Morocco is too much to take, cool down with our New York Style, Ice Cold, Lucite Jewelry Collections; The Coolest Trend This Season.

HOW TO READ THE NEW METROPACK:

NEW on Maps:

- We color blocked the zones and Drive Aisle Tables (DI, Z1....ETC)
- Those colors correspond with the overview photos of the zones on the maps providing visual guidance for better understanding of the Floorset as a whole.
- We named the tables & walls according to the items placed on it

NEW on Zone Pages:

- Drive Aisle Tables and Display Wall are the first to follow the Maps.
- Now, you can find all D.A .tables in one section, creating an D.A. "Zone"
- Zones 1-4 are directly after D.A. & Display Wall pages.
- The Page Headers and the names are color-coded to correspond with the zoning on the Maps.
- Included are "Birds Eye View" diagrams to help aid fixture and product placement.
- The diagrams include various iterations of the same table if your stores have different fixtures than what's captured on the photograph.
- Key to Display Elements shown on diagrams are provided below and on each individual page with tables.
- Frames and (Camera) Icon around the Bird's Eye Diagram indicates the table captured on photograph.
- Each Page has a section designated for "Notes to Remember" containing crucial information regarding that particular table or zone, visual tips, Etc.
- Jewelry presentation quantities are now documented in the description area next to style numbers.
- One Zone is on one page, Table (Front) and Wall (Back) are located on the same sheet.

NEW on Fixture Pages:

- New Fixture documenting template has 8 Columns and 9 Rows each "cell" house one style number a color code and a description.
- The location of the cell, (I.e. C3 R4) corresponding with the location of the item on the photograph.
- This new template provides visual aid for placement as well as all necessary information for the product

All Jewelry Fixture should remain full, if sell down occurs remove from displays to fill fixtures.

Chain Stores:

- We created a completely separate section for Chain Stores. It follows the same concept and format as the Side by Side and 3Door.

FIXTURE KEY

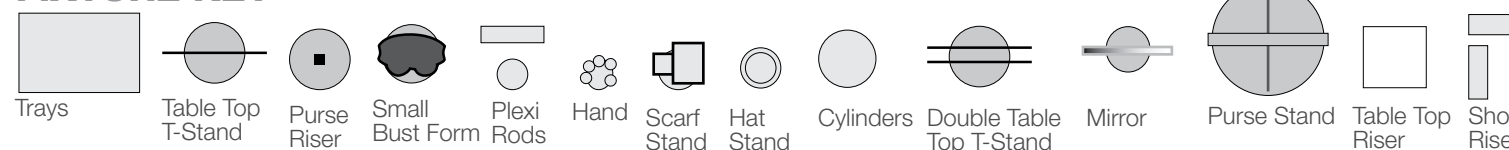

ZONE 1: PAGES 9-10



ZONE 3: PAGES 13-14



DRIVE AISLE: PAGES 5-8

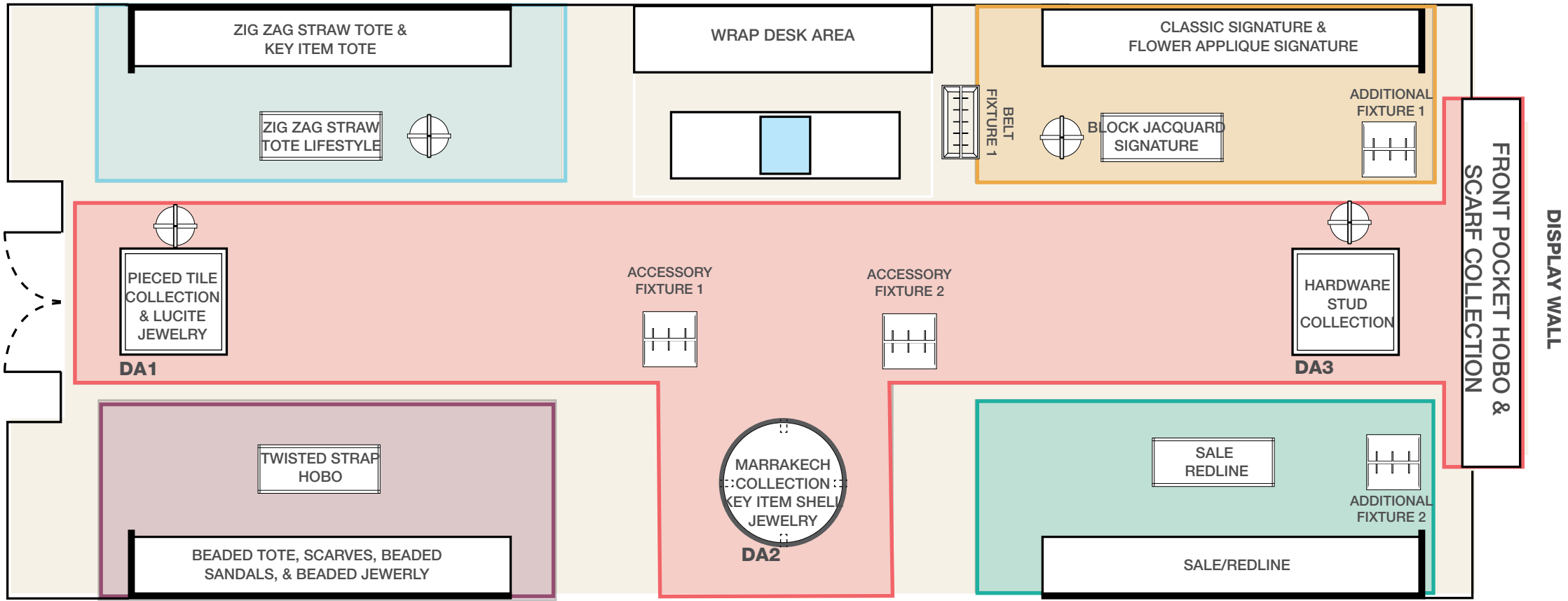

ENTRANCE TO APPAREL

ZONE 2: PAGES 11-12



ZONE 4: PAGES 15-16



SUMMER 2010 • 3Door Map

DRIVE AISLE: PAGES 5-8



LARGE WALL: PAGE 45



* STORE ARE TO ADD FLOWER APPLIQUE TO WALL SEE PAGE 45 FOR ADDITIONAL DIRECTIONS

ZONE 4: PAGES 46



* REFER TO PAGE 46 FOR SALE SETUP UP IN APPAREL SALE

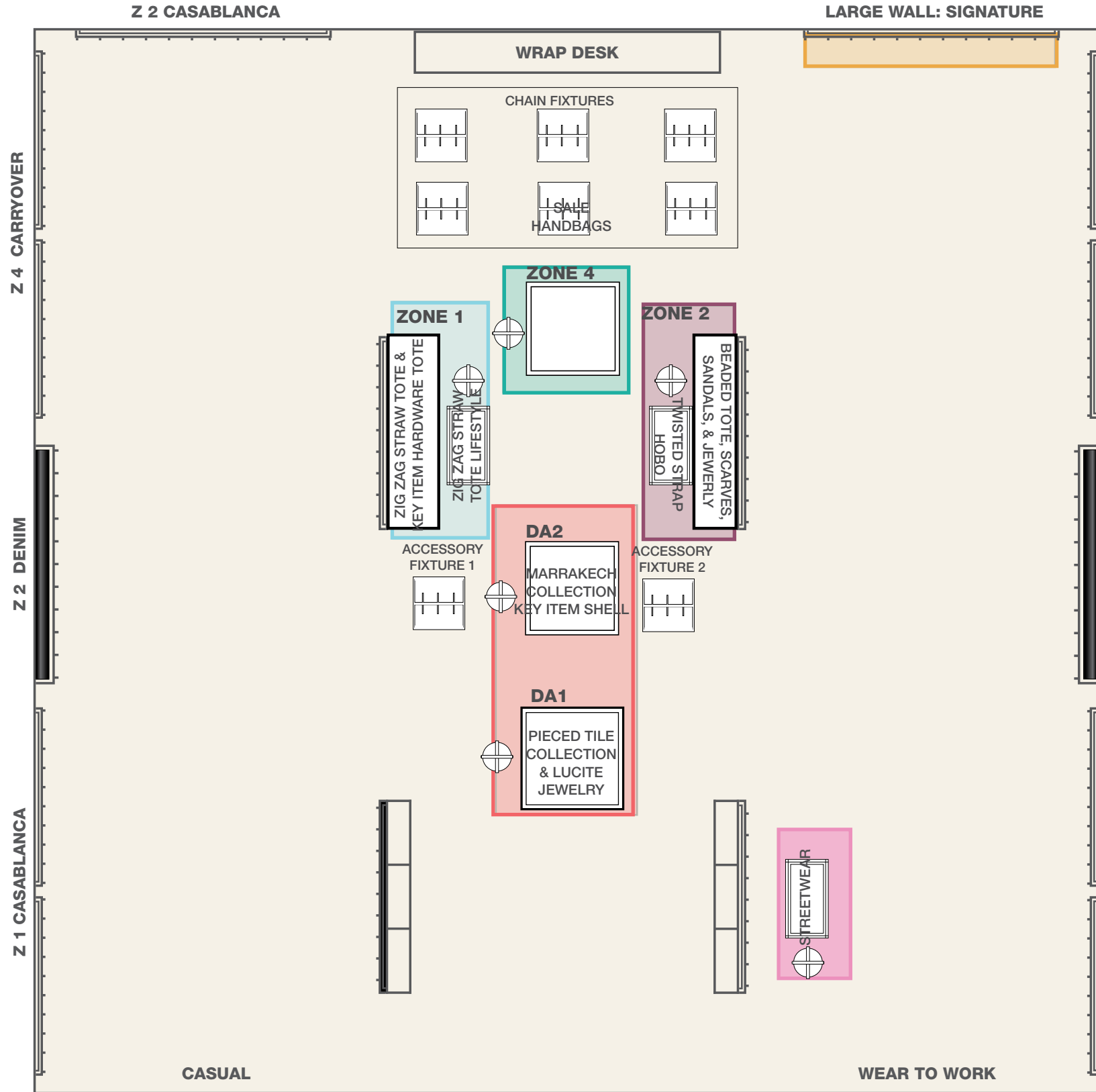

ZONE 1: PAGES 9-10



ZONE 2: PAGES 11-12



PRINTED HOBO: PAGE 20



FRONT



BACK



DRIVE AISLE TABLE 1 | FRONT

- | | |
|--|---|
| 1. Purse Riser (Back Left):
6124 (898) Pieced Tile Hobo | Bust Form Back:
1121 (046) Long 1 Row Lucite |
| Purse Riser (Front Left):
6219 (898) Pieced Tile XBody | 1118 (046) Short 2 Row Lucite |
| Double Table Top T-Stand: | Table Top Riser (Left):
7259 (006) Patchwork Flip Flop |
| Row 1:
1121 (074) Long 1 Row Lucite | 3. Top of Table:
6279 (898) Pieced Tile Wallet |
| 1121 (046) Long 1 Row Lucite | 6279 (006) Pieced Tile Wallet |
| Row 2:
1118 (074) Short 2 Row Lucite | Plexi Rods:
9776 (046) Multi Bead Stretch |
| 1118 (046) Short 2 Row Lucite | 9777 (046) Silver Beaded Cuff |
| Purse Riser (Back Right):
6124 (006) Pieced Tile Hobo | 9778 (074) Lucite Stretch |
| Purse Riser (Front Right):
6219 (006) Pieced Tile XBody | 9787 (002) 3D Design Hinge |
| 2. Table Top Riser:
7259 (898) Patchwork Flip Flop | 4. Tray (Left):
7259 (898) Patchwork Flip Flop |
| Bust Form Front
1118 (074) Short 2 Row Lucite | Bottom of Table:
6220 (006) Pieced Tile Tote |
| | Tray (Right):
7259 (006) Patchwork Flip Flop |

DRIVE AISLE TABLE 1 | PURSE STAND

- | | |
|------------------------------------|------------------------------|
| 1. 6134 (006) Pieced Tile Wristlet | 6214 (006) Pieced Tile Hobo |
| 6134 (898) Pieced Tile Wristlet | 6214 (898) Pieced Tile Hobo |
| 2. 6219 (006) Pieced Tile XBody | 6219 (898) Pieced Tile XBody |

DRIVE AISLE TABLE 1 | BACK

- | | |
|---|--|
| 1. Table Top T-Stand:
1123 (046) Long 3 Row Chunky | 2. Bottom of Table:
6220 (898) Pieced Tile Tote |
| 1124 (046) Long 1 Row Frozen | |

BIRD'S EYE VIEW

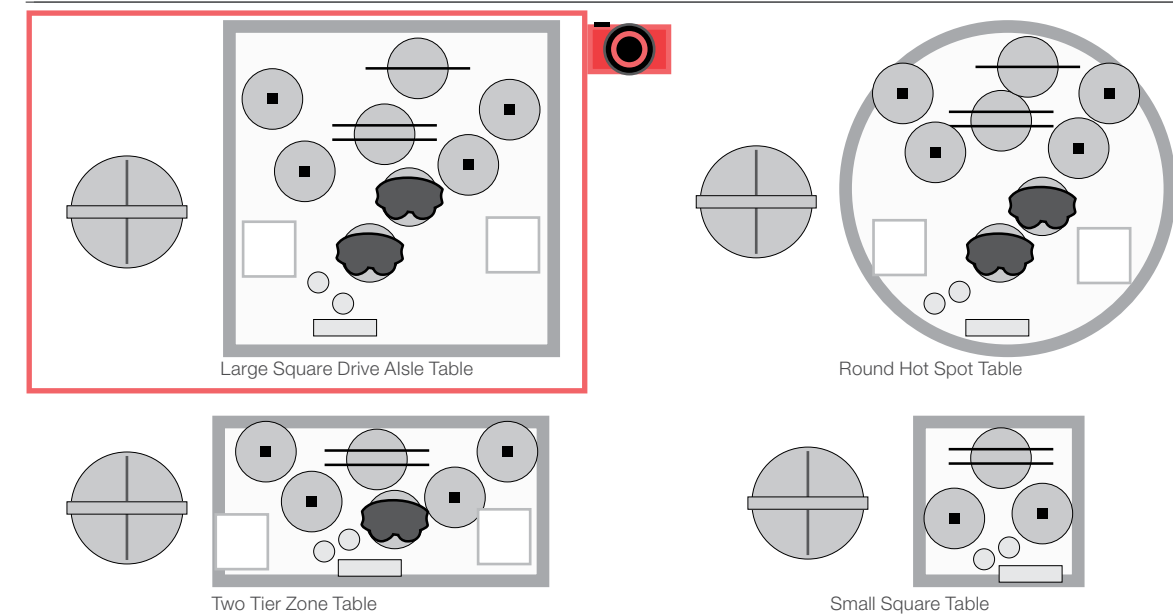

FIXTURE KEY

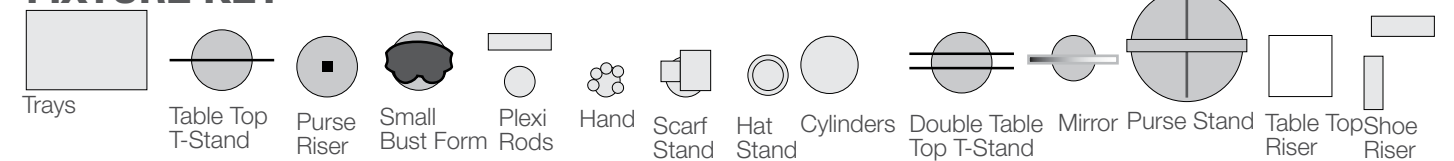

NOTES TO REMEMBER

- Maintain a full jewelry presentation on this table.
- Acrylic rods should feel full and diverse.
- Stores are to place 3 of each wallets on tabletop.

DRIVE AISLE TABLE 2 | FRONT

- | | | | | |
|-----------------------------|-------------------------------------|-------------------------------------|-------------------------------------|-------------------------------------|
| 1. Purse Stand (Back Left): | 6223 (006) Marrakech Snake Satchel | 6257 (006) Marrakech Snake Wristlet | 2. Table Top Riser (Back Left): | 7256 (006) Marrakech Sandal |
| Purse Stand (Middle Left): | 6223 (298) Marrakech Snake Satchel | 6257 (298) Marrakech Snake Wristlet | Table Top Riser (Front Middle): | 7256 (938) Marrakech Sandal |
| Purse Stand (Middle Right): | 6223 (938) Marrakech Snake Satchel | 6257 (938) Marrakech Snake Wristlet | 3. Top of Table: | 6257 (198) Marrakech Snake Wristlet |
| Purse Stand (Front Right): | 6223 (198) Marrakech Snake Satchel | 6257 (198) Marrakech Snake Satchel | 6257 (938) Marrakech Snake Wristlet | 6257 (298) Marrakech Snake Wristlet |
| | 6257 (006) Marrakech Snake Wristlet | | 6257 (006) Marrakech Snake Wristlet | 7032 (006) Marrakech Snake Belt |
| | | | 7032 (006) Marrakech Snake Belt | 7032 (938) Marrakech Snake Belt |

DRIVE AISLE TABLE 2 | PURSE STAND

- | | |
|---------------------------------------|---------------------------------------|
| 1. 6223 (198) Marrakech Snake Satchel | 2. 6223 (938) Marrakech Snake Satchel |
| 6223 (298) Marrakech Snake Satchel | 6223 (0060) Marrakech Snake Satchel |

DRIVE AISLE TABLE 2 | BACK

- | | | | |
|-----------------------------------|--------------------------------|-----------------------------------|--------------------------------|
| 1. Purse Riser (Back Left): | 1082 (197) KI Long Ombre Shell | Purse Riser (Front Right): | 1082 (599) KI Long Ombre Shell |
| 9760 (197) Key Item Shell Stretch | | 9760 (599) Key Item Shell Stretch | |
| Purse Riser (Middle): | 1082 (899) KI Long Ombre Shell | 2. Tray: | 7256 (938) Marrakech Sandal |
| 9760 (899) Key Item Shell Stretch | | 7256 (006) Marrakech Sandal | |

BIRD'S EYE VIEW

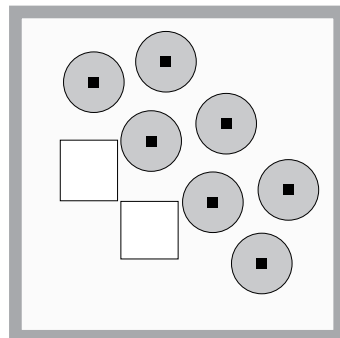

Large Square Drive Aisle Table

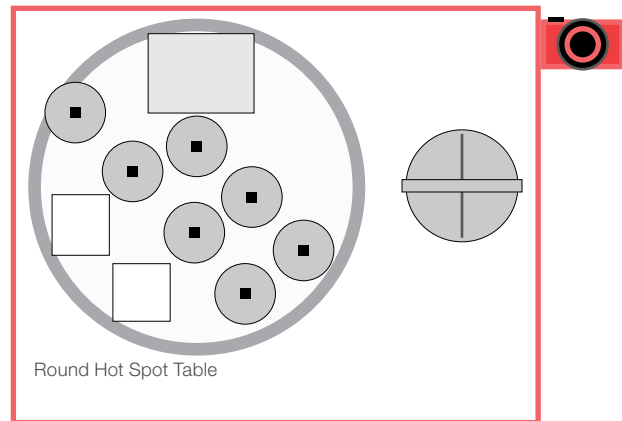

Round Hot Spot Table

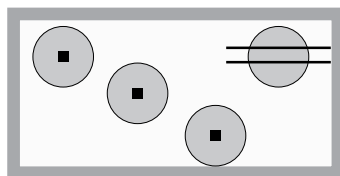

Two Tier Zone Table

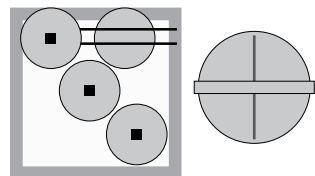

FIXTURE KEY

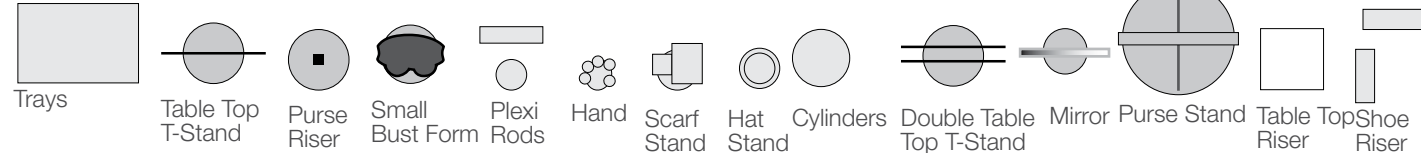

NOTES TO REMEMBER

- Use Table Top as display surface, house bags on bag stand next to table.
- In case of limited tabletop surface omit black bag from display. Refer to bird's eye view.
- When merchandising on double tier table, place a size run of sandals in large trays on the base of the table.
- Merchandise Key Item Jewelry on bag stands as shown on picture. Necklaces hanging, bracelets placed on base of bag stand
- Display belts buckled, and forming the shape of #8.

FRONT



BACK



FRONT



DRIVE AISLE TABLE 3 | FRONT

- | | |
|-----------------------------------|-----------------------------------|
| 1. Table Top T-Stand (Left Back): | 2. Table Top Riser: |
| 6268 (016) Hammered Stud Tote | 7242 (016) Strappy Stud Sandal |
| 6268 (006) Hammered Stud Tote | Top of Table: |
| 6793 (134) Raven Reptile | 6105 (016) Hammered Stud Wallet |
| Purse Riser (Front): | 3. 6090 (006) Hammered Stud XBody |
| 6268 (016) Hammered Stud Tote | 6268 (006) Hammered Stud Tote |
| 6793 (804) Raven Reptile | 6268 (898) Hammered Stud Tote |
| Table Top T-Stand (Front Right): | 4. 7242 (016) Strappy Stud Sandal |
| 6108 (016) Flap Over Wristlet | 7242 (006) Strappy Stud Sandal |
| 6108 (006) Flap Over Wristlet | 7242 (898) Strappy Stud Sandal |

DRIVE AISLE TABLE 3 | PURSE STAND

- | | |
|------------------------------|------------------------------|
| 1. 6096 (016) Flap Over Hobo | 2. 6094 (016) Flap Over Tote |
| 6096 (006) Flap Over Hobo | 6094 (006) Flap Over Tote |

DRIVE AISLE TABLE 3 | BACK

- | | |
|---------------------------------|---------------------------------|
| 1. Table Top T-Stand | 2. Bottom of Table |
| 6090 (016) Hammered Stud XBody | 6090 (898) Hammered Stud XBody |
| 6090 (006) Hammered Stud XBody | 6105 (898) Hammered Stud Wallet |
| Table Top Riser: | 6105 (103) Hammered Stud Wallet |
| 7242 (006) Strappy Stud Sandal | 6268 (103) Hammered Stud Tote |
| Top of Table | 6090 (103) Hammered Stud XBody |
| 6105 (006) Hammered Stud Wallet | |

BIRD'S EYE VIEW

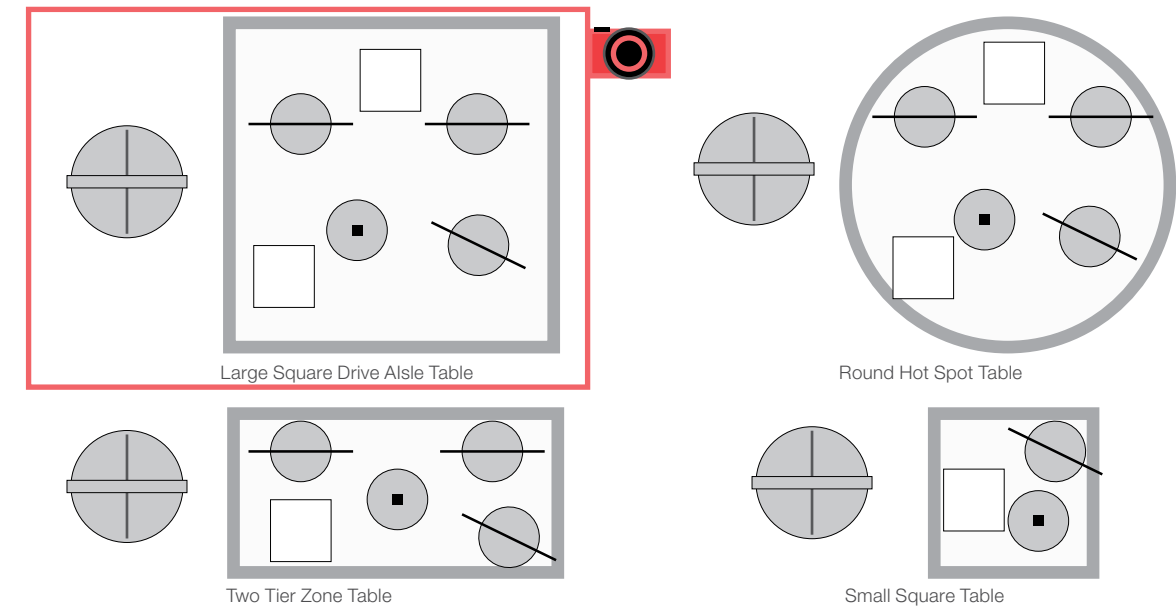

BACK



FIXTURE KEY

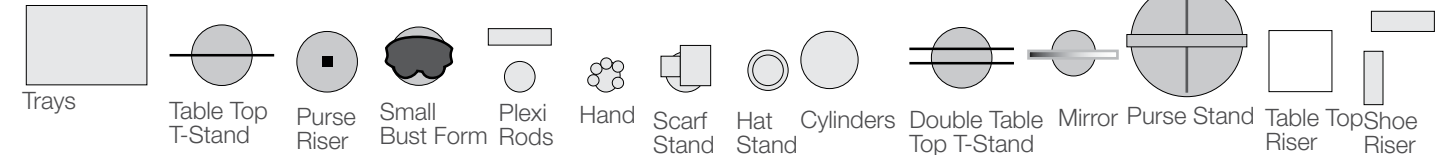

NOTES TO REMEMBER

- Smaller stores that have a 3rd Drive Aisle Table place this merchandise onto Zone 4 table and move Zone 4 table merchandise into Zone 4 cabinet with other 30% off products.

DISPLAY WALL | CABINET 1

- 1. 6803 (103) Multi Straw Hat
- 6100 (349) Front Pocket Hobo
- 6798 (011) Multi Butterfly Scarf
- 7280 (922) Knotted Wedge
- 2. 6804 (726) Natural Ribbed Straw Hat
- 6803 (103) Multi Straw Hat
- 3. 6100 (349) Front Pocket Hobo
- 6100 (938) Front Pocket Hobo
- 6100 (156) Front Pocket Hobo

DISPLAY WALL | CABINET 2

- 1. 6751 (347) Battenburg Lace
- 6858 (011) Milky Way
- 6751 (016) Battenburg Lace
- 6799 (011) Easter Egg Scarf
- 6822 (347) Quirky Ombre Scarf
- 6798 (011) Multi Butterfly Scarf
- 6820 (597) Purple Multi Nubby
- 6822 (290) Quirky Ombre Scarf
- 6751 (290) Battenburg Lace
- 6857 (406) Pastel Open Weave
- 2. 7280 (230) Knotted Wedge
- 7280 (922) Knotted Wedge
- 7280 (838) Knotted Wedge
- 7280 (059) Knotted Wedge
- 7280 (771) Knotted Wedge
- 7280 (816) Knotted Wedge
- 7280 (006) Knotted Wedge

DISPLAY WALL | CABINET 3

- 1. 6803 (298) Multi Straw hat
- 7280 (230) Knotted Wedge
- 6798 (011) Multi Butterfly Scarf
- 6100 (230) Front Pocket Hobo
- 2. 6803 (298) Multi Straw Hat
- 6804 (726) Natural Ribbed Straw Hat
- 3. 6100 (230) Front Pocket Hobo
- 6100 (006) Front Pocket Hobo

DISPLAY WALL



ZONE 1



NOTES TO REMEMBER

TABLE:

- Create a Lifestyle display of the Zig Zag Straw Tote, Wedge, Hat and Belts.
- To display Belts place a size of the Large, Medium and Small belts buckled and in that order in front of the mirror.
- House two size runs of the wedges on table base.
- Use medium tray as platform to house 2 styles of sunglasses.

WALLS:

- For Belt presentation use Large, Medium and Small belts buckled and placed in that order under the Straw Wedges.
- Sell down: if you running low on Key Item Bags, replace cabinet with full size "Straight" Small Base Mannequins shown on page 18 using the outfit with the Zig Zag Tote and Fedora Beaded Hat.

For Additionl Cabinets refer to page 18 Mannequins in the wall:

ZONE 1 | TABLE

1. Table Top T-Stand:
 - 1155 (011) Many Multi Strands (6x)
- Purse Riser:
 - 6864 (726) Beaded Fedora
 - 6162 (898) Zig Zag Straw Tote
 - 6824 (398) Multi Smock Scarf
- Shoe Riser:
 - 7258 (898) Straw Crossover Wedge
2. Top of Table:
 - 6864 (726) Beaded Fedora
- Tray:
 - 7379 (895) Glam Rocker
 - 7379 (010) Glam Rocker
- Top of Table:
 - 7034 (898) Straw Stretch Belt
3. Bottom of Table:
 - 7258 (898) Straw Crossover Wedge

ZONE 1 | PURSE STAND

1. 6162 (898) Zig Zag Straw Tote

BIRD'S EYE VIEW

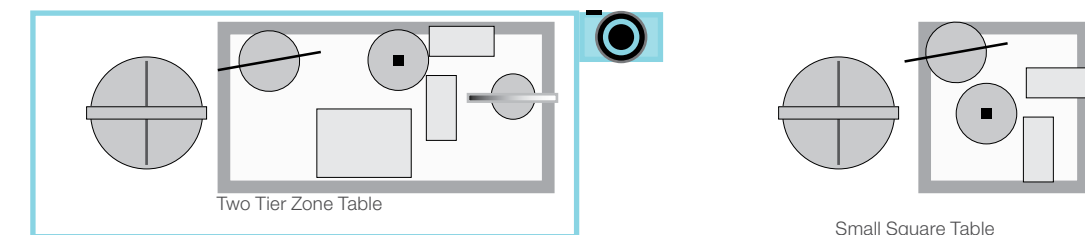
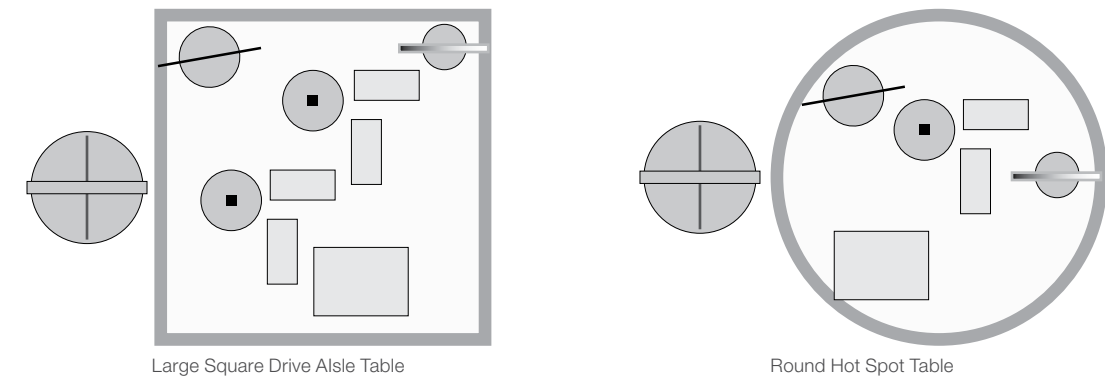

FIXTURE KEY

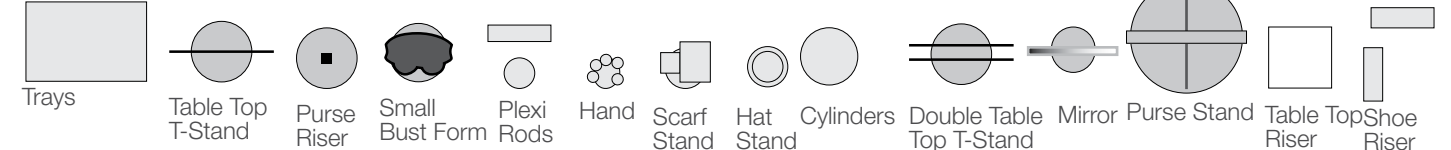

CABINET 1



- 1. 6271 (847) Hardware Tote
- 2. 6271 (230) Hardware Tote
- 3. 6271 (847) Hardware Tote

CABINET 2



- 1. 6162 (298) Zig Zag Straw Tote
- 7258 (298) Straw Crossover Wedge
- 2. 7258 (298) Straw Crossover Wedge
- 3. 7034 (298) Straw Stretch Belt
- 1233 (016) Elastic Neck Tee
- 1155 (011) Many Multi Stands
- 7034 (298) Straw Stretch Belt
- 4. 7281 (230) Ombre Flower Sandal
- 7281 (770) Ombre Flower Sandal
- 7281 (347) Ombre Flower Sandal
- 7281 (965) Ombre Flower Sandal
- 7281 (896) Ombre Flower Sandal
- 7281 (965) Ombre Flower Sandal
- 7281 (006) Ombre Flower Sandal
- 7281 (011) Ombre Flower Sandal
- 7281 (006) Ombre Flower Sandal

CABINET 3



- 1. 6271 (016) Hardware Tote
- 7281 (230) Ombre Flower Sandal
- 2. 6271 (016) Hardware Tote
- 3. 6271 (006) Hardware Tote

CABINET 4



- 1. 6162 (198) Zig Zag Straw Tote
- 7258 (198) Straw Crossover Wedge
- 2. 7258 (198) Straw Crossover Wedge
- 3. 1233 (347) Elastic Neck Tee
- 7034 (198) Straw Stretch Belt
- 1144 (011) Long Multi n Coins
- 7034 (198) Straw Stretch Belt
- 4. 7279 (016) Double Ruffle Flip Flop
- 7279 (002) Double Ruffle Flip Flop
- 7279 (965) Double Ruffle Flip Flop
- 7279 (006) Double Ruffle Flip Flop
- 7279 (290) Double Ruffle Flip Flop
- 7279 (347) Double Ruffle Flip Flop
- 7279 (001) Double Ruffle Flip Flop
- 7279 (896) Double Ruffle Flip Flop
- 7279 (001) Double Ruffle Flip Flop

CABINET 5



- 1. 6271 (337) Hardware Tote
- 2. 6271 (347) Hardware Tote
- 3. 6271 (337) Hardware Tote

ZONE 2



NOTES TO REMEMBER

TABLE

- Use medium tray as platform to house jewelry and small tray as platform to display.
- Maintain jewelry presentations on this table.
- Acrylic rods should feel full and diverse.
- Place the following 1135 (398) Long Ethnic Sead Bead so it hangs off the platform
- House a size run each of the Tribal Weave Wedge on table base.
- Hang scarves on display hangers.

WALLS

- For scarf presentation on bullet heads, twist two styles of each scarf shown together and place it around the neck, creating a turban-like appearance.
- When merchandising scarves in cabinet make sure that one end touches the bottom shelves, creating an uneven hanging.
- Repeat this hanging technique on all the scarves and make sure it's always the right end that's longer.
- For store that do not have additional Cabinets replace the Criss Cross Sandal with the following:
7282 (006) Horseshoe Sandal
7296 (006) Bugle Bead T-Strap

ZONE 2 | TABLE

1. Small Bust Form (Back):	1138 (011) Chunky Caterpillar	9786 (898) 2 Row Stone Stretch
	1136 (699) Long 2 Row Red Murano	
Small Bust Form (Front):	1138 (398) Chunky Caterpillar	Purse Riser (Front):
	1127 (699) Short 2 Row Murno (2x)	6278 (198) Twisted Strap Hobo
Double Table Top T-Stand:		Purse Riser (Back):
Row 1:		6278 (298) Twisted Strap Hobo
1127 (398) Short 2 Row Murno (2x)		2. Plexi Rods:
1130 (398) Short Ethnic 1 Row (2x)		9779 (699) Swirl Stretch
1135 (398) Long Ethnic Sead Bead (2x)		9779 (398) Swirl Stretch
1142 (398) Long Blue Green 1 Row Chunk		9780 (699) 5 Row Murano Stretch
1136 (699) Long 2 Row Red Murano (2x)		9781 (898) 4 Row Nugget Shell Stretch
1135 (699) Long Ethnic Sead Bead (2x)		9781 (398) 4 Row Nugget Shell Stretch
1130 (699) Short Ethnic 1 Row (2x)		9782 (398) 2 Row Large Bead Stretch
1127 (699) Short 2 Row Murno (2x)		9786 (399) 2 Row Stone Stretch
Row 2:		9786 (197) 2 Row Stone Stretch
9779 (699) Swirl Stretch		9786 (898) 2 Row Stone Stretch
9779 (398) Swirl Stretch		Tray:
9780 (699) 5 Row Murano Stretch		1135 (398) Long Ethnic Sead Bead
9781 (898) 4 Row Nugget Shell Stretch		Tray (Right):
9781 (398) 4 Row Nugget Shell Stretch		7296 (897) Tribal Weave Wedge
9782 (398) 2 Row Large Bead Stretch		3. Bottom of Table:
9786 (399) 2 Row Stone Stretch		7296 (897) Tribal Weave Wedge
9786 (197) 2 Row Stone Stretch		7296 (006) Tribal Weave Wedge

ZONE 2 | PURSE STAND

1. 6859 (298) Moroccan Romance
6756 (922) Square Scarf w Chain
6859 (198) Moroccan Romance
2. 6278 (298) Twisted Strap Hobo
6278 (198) Twisted Strap Hobo

BIRD'S EYE VIEW

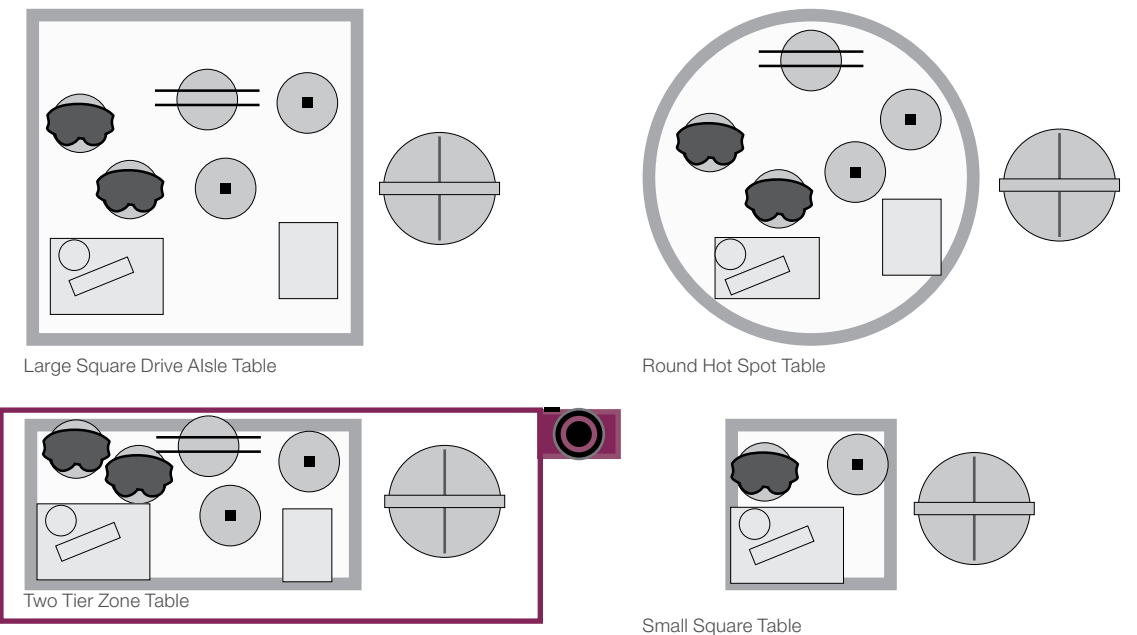

FIXTURE KEY

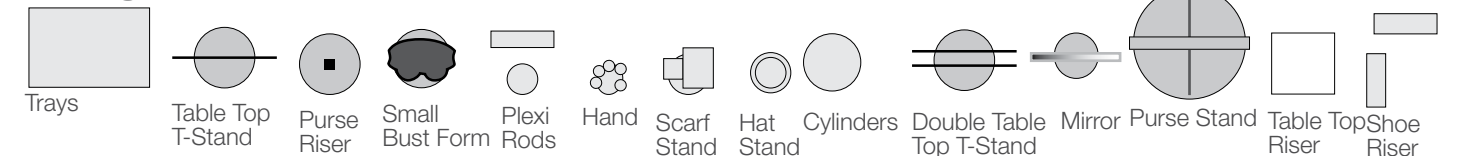

ADDITIONAL



- 1. 6824 (698) Multi Smock Scarf
- 6758 (771) Lurex Vertical Stripe
- 6824 (398) Multi Smock Scarf
- 6758 (361) Lurex Vertical Stripe
- 6824 (103) Multi Smock Scarf
- 2. 7282 (006) Horseshoe Sandal
- 7296 (006) Bugle Bead T-Strap

CABINET 2



- 1. 6142 (688) Beaded Tote
- 2. 7294 (198) Round Bead Sandal
- 7294 (698) Round Bead Sandal
- 3. 8165 (771) S/S Shirred Top
- 7030 (816) Beaded Cording Belt
- 6824 (698) Multi Smock Scarf
- 6758 (771) Lurex Vertical Stripe

CABINET 1



- 1. 6142 (688) Beaded Tote
 - 2. 7030 (758) Beaded Cording Belt
 - 7030 (816) Beaded Cording Belt
 - 7030 (006) Beaded Cording Belt
 - 3. 7285 (006) Criss Cross Sandal
 - 7285 (002) Criss Cross Sandal
- For store that do not have additional Cabinets replace the Criss Cross Sandal with the following:
- 7282 (006) Horseshoe Sandal
 - 7296 (006) Bugle Bead T-Strap

CABINET 3



- 1. 6142 (758) Beaded Tote
- 2. 6142 (816) Beaded Tote
- 3. 1147 (197) Long Knotted Sead Bead
- 1147 (699) Long Knotted Sead Bead
- 1147 (799) Long Knotted Sead Bead
- 1147 (899) Long Knotted Sead Bead
- 1147 (399) Long Knotted Sead Bead
- 1147 (006) Long Knotted Sead Bead

CABINET 4



- 1. 6142 (758) Beaded Tote
- 2. 7294 (698) Round Bead Sandal
- 7294 (198) Round Bead Sandal
- 3. 8165 (128) S/S Shirred Top
- 7030 (758) Beaded Cording Belt
- 6824 (398) Multi Smock Scarf
- 6758 (361) Lurex Vertical Stripe

CABINET 5



- 1. 6824 (698) Multi Smock Scarf
- 6758 (771) Lurex Vertical Stripe
- 6824 (398) Multi Smock Scarf
- 6758 (361) Lurex Vertical Stripe
- 6824 (103) Multi Smock Scarf
- 2. 7289 (898) Double Strap Bead Sandal
- 7282 (898) Horseshoe Sandal

ZONE 3



NOTES TO REMEMBER

- TABLE:
- House Spring Cell Phone Cases with New blocked Jacquard Cell cases.
 - Use Small tray to hold Coin Purse

- WALLS
- Visual tip: Open Appliqué Flower Wallet slightly so it's stands more firmly when displayed.

For Additional Cabinets refer to page 19

ZONE 3 | PURSE STAND

- 6252 (006) Linen Mix Wristlet
6252 (897) Linen Mix Wristlet
- 6233 (006) Linen Mix Hobo
6233 (897) Linen Mix Hobo

ZONE 3 | TABLE

- Table Top T-Stand:
6272 (628) Cell Phone Pouch
6273 (897) Block/Jacquard Cell Case
6272 (965) Cell Phone Pouch
6273 (006) Block/Jacquard Cell Case
6272 (006) Cell Phone Pouch
- Top of Table:
6149 (897) Block Jacquard Wallet
6180 (897) Block Jacquard Hobo
6179 (897) Block Jacquard Tote
Tray:
6152 (897) Block/Jacquard Coin Purse
6152 (006) Block Jacquard Coin Purse
Top of Table:
6180 (006) Block Jacquard Hobo
6179 (006) Block Jacquard Tote
6149 (006) Block Jacquard Wallet
- Bottom of Table:
6179 (897) Block Jacquard Tote
6180 (897) Block Jacquard Hobo
6179 (006) Block Jacquard Tote
6180 (006) Block Jacquard Hobo

BIRD'S EYE VIEW

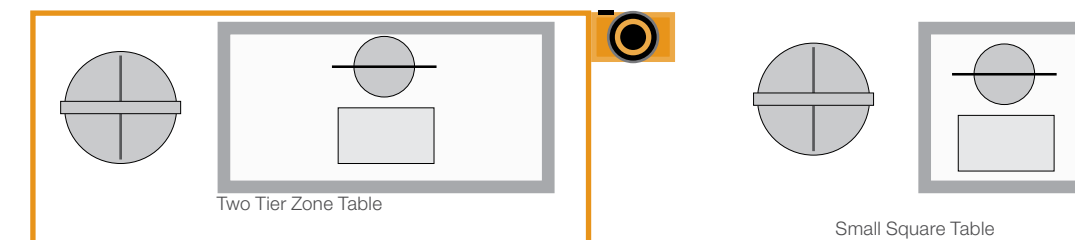
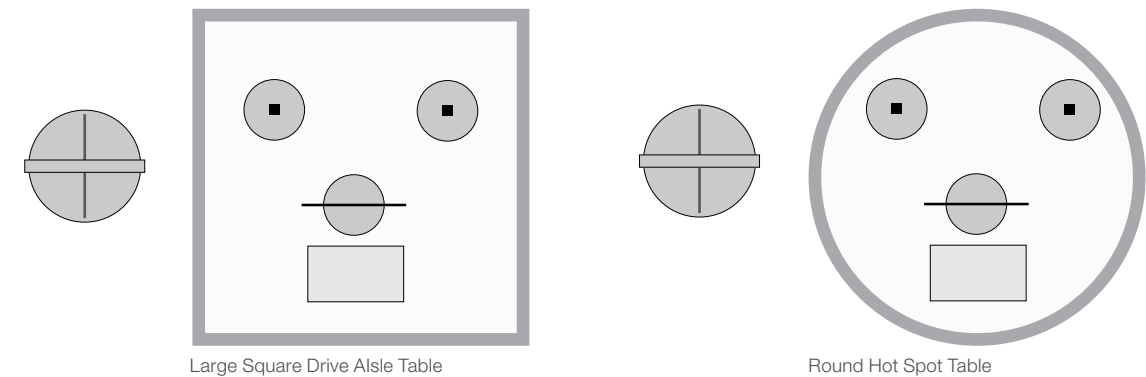

FIXTURE KEY

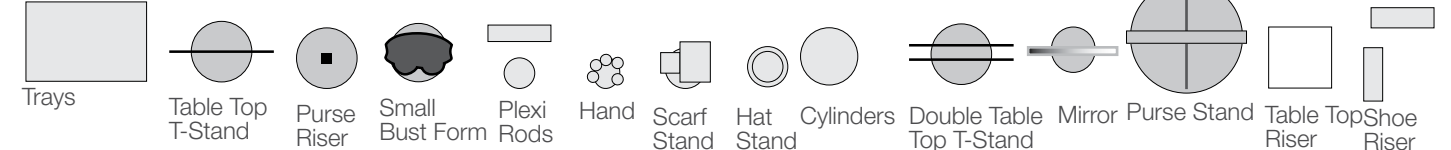

CABINET 1



- 1. 7286 (091) Script Turnlock Satchel
- 2. 6320 (091) Scribble Foldover Tote
- 3. 7580 (091) Scribble Big Buckle Tote

CABINET 2



- 1. 7579 (091) Scribble Big Buckle Satchel
- 7662 (091) Scribble Signature Wallet
- 8162 (091) Script Pushlock Coin
- 2. 8130 (091) Side Drawstring Satchel
- 7689 (091) Scribbles Metal Clip Bag
- 3. 8206 (091) Belted Hardware Demi (Incorrect Picture)
- 6224 (091) Scribbles Buckle Wallet
- 7286 (091) Script Turnlock Satchel
- 4. 7579 (091) Scribbles Big Buckle Satchel
- 8044 (091) Logo Script Center Cross Body
- 7580 (091) Scribble Big Buckle Tote
- 5. 7662 (091) Scribble Signature Wallet
- 7663 (091) Scribbles Wristlet
- 8162 (091) Script Pushlock Coin
- 8070 (091) Signature Stud Slim Envelope

CABINET 3



- 1. 6248 (091) Applique Flower Hobo
- 6269 (091) Applique Flower Hobo
- 2. 6248 (091) Applique Flower Hobo
- 6269 (091) Applique Flower Wallet
- 3. 6248 (006) Applique Flower Hobo
- 6269 (006) Applique Flower Wallet

CABINET 4



- 1. 6320 (965) Scribbles Foldover Tote
- 7662 (965) Scribble Signature Wallet
- 8162 (006) Script Pushlock Coin
- 2. 7689 (965) Scribbles Metal Clip Bag (Incorrect Picture)
- 8206 (006) Belted Hardware Demi
- 3. 8130 (006) Side Drawstring Satchel
- 6224 (965) Scribbles Buckle Wallet
- 7286 (006) Script Turnlock Satchel
- 4. 7580 (965) Scribbles Big Buckle Tote
- 8044 (006) Logo Script Center Cross Body
- 7579 (965) Scribbles Big Buckle Satchel
- 5. 7662 (965) Scribble Signature Wallet
- 8070 (006) Signature Stud Slim Envelope
- 7663 (965) Scribbles Wristlet
- 8162 (006) Script Pushlock Coin

CABINET 5

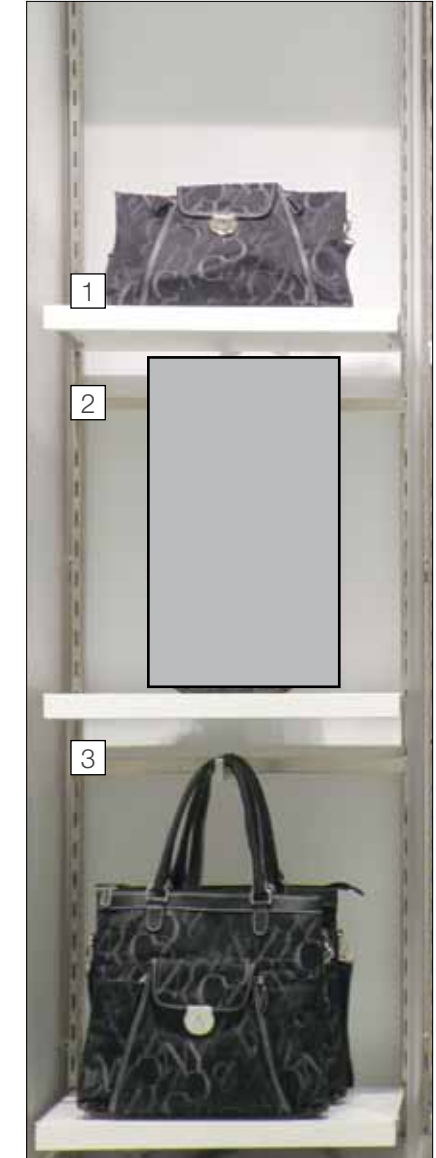

- 1. 6320 (965) Scribbles Foldover Tote
- 2. 7579 (965) Scribbles Big Buckle Satchel
- 3. 6320 (965) Scribbles Foldover Tote

*Place Signature Wristlets and Wallets on shelf as shown in Cabinet 2.

ZONE 4



ZONE 4 | TABLE

- Stores are to place any sale merchandise on this table.
- Place product based on inventory and price point.
- Stores should use photo shown to right for visual guide when executing Table.
- Small Stores should place the Hammered Stud Collection and place the Slouchy Tote in the Wall.

3DOOR

- Place all Sale Merchandise in Apparel Sale Zone as shown on page 46 or on Drive Aisle Table 3 as shown on 3Door Map

BIRD'S EYE VIEW

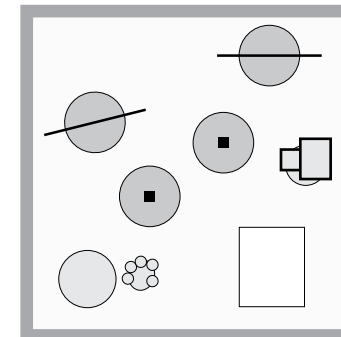

Large Square Drive Aisle Table

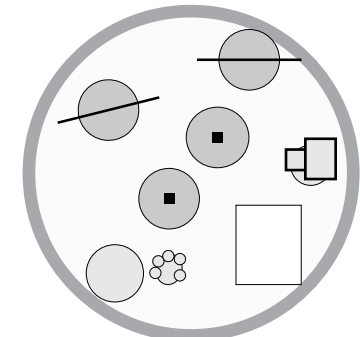

Round Hot Spot Table

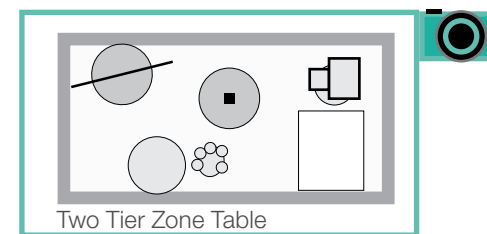

Two Tier Zone Table

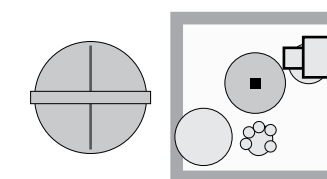

Small Square Table

FIXTURE KEY

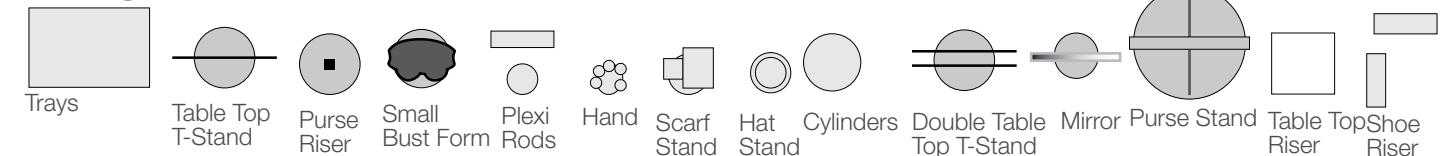

CABINET 1



CABINET 2



CABINET 3



CABINET 4



CABINET 5



ZONE 4 | WALL

- Stores are to place any sale merchandise in the Wall.
- Place product based on inventory and price point.
- Stores should use photo shown for visual guide when executing Wall.

3DOOR

- Place all Sale Merchandise in Apparel Sale Zone as shown on page 46 or on Drive Aisle Table 3 as shown on 3Door Map

WRAP DESK NOTES:

NEW YORK LIP BALM

Lip Balm should be placed in a bowl following the earlier direction.
 Flavors that should be added to the bowl upon receipt.
 They are Cranberry Pear, and Caramel Apple

NEW YORK GLOSSY

Glossy should be placed in a bowl following the earlier direction. Be sure to place all colors in bowl
 There are all colors that should be added to the bowl upon receipt

CANDY BOWLS

Candy Bowls should be placed at registers as previously directed with the corresponding marketing.

NY&C FRAGRANCE

For stores that were selected to receive the NY&C Fragrance they should still continue to house the Fragrance at the Wrap Desk

WRAP DESK



DISPLAY CASE

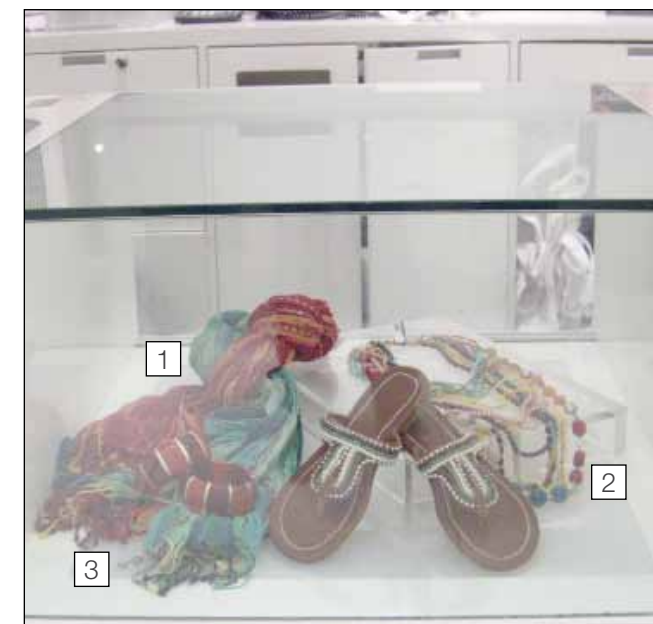

WRAP DESK | DISPLAY CASE

- | | | | |
|----|------|-------|--------------------|
| 1. | 6824 | (698) | Multi Smock Scarf |
| | 6824 | (103) | Multi Smock Scarf |
| 2. | 1144 | (011) | Long Multi n Coins |
| | 1155 | (011) | Many Multi Stands |
| | 7282 | (898) | Horseshoe Sandal |
| 3. | 9779 | (699) | Swirl Stretch (2x) |

NOTES TO REMEMBER:

Use Small tray as platform to elevate necklaces and provide support for the flip flops

ADDITIONAL CABINET RIGHT



ZONE 1 | ADDITIONAL CABINET RIGHT

M1.2037	(477)	Dove Graphic Tank
2236	(016)	Basic Denim Jacket
2608	(126)	Stripe Roll UP Short
6162	(298)	Zig Zag Straw Tote
6864	(726)	Beaded Fedora
M2. 2428	(016)	Rb Tank
2058	(016)	Pintuck Tunic
4189	(070)	Skinny Ankle Cloud
6822	(290)	Ouirky Ombre Scarf
6271	(230)	Key Item Hardware Tote

NOTES TO REMEMBER:

- (M1) place a Beaded Fedora Hat in her hand.
- (M2) Use the 6822 (290) Ouirky Ombre Scarf as belt loosely tied around her waist.

ADDITIONAL CABINET LEFT



ZONE 1 | ADDITIONAL CABINET LEFT

M3.2235	(098)	Basic Denim Jacket
2037	(922)	Dove Grapphic Tank
2647	(813)	Boyfriend Chino Short
6162	(198)	Zig Zag Straw Tote
6864	(726)	Beaded Fedora
M4. 2428	(474)	Rib Tank
2058	(477)	Pintuck Tunic
5271	(016)	Skinny Ankle Jean
6824	(103)	Multi Smock Scarf
6271	(347)	Key Item Hardware Tote
1147	(699)	Long Knotted Beaded SD BD

NOTES TO REMEMBER:

- (M3) place a Beaded Fedora Hat hat in her hand.
- (M4) make sure that the scarf and the handbag matches in color.

ADDITIONAL CABINET RIGHT



ZONE 3 | ADDITIONAL CABINET RIGHT

- | | | |
|---------|-------|--------------------|
| 1. 8157 | (217) | S/L Sequin Tank |
| 3467 | (684) | RL Cardigan |
| 9148 | (091) | Skinny Keeper Belt |
| 8157 | (686) | S/L Sequin Tank |
| 3467 | (684) | RL Cardigan |
| 9148 | (091) | Skinny Keeper Belt |

ADDITIONAL CABINET LEFT



ZONE 3 | ADDITIONAL CABINET LEFT

- | | | |
|---------|-------|--------------------|
| 1. 8157 | (006) | S/L Sequin Tank |
| 3467 | (006) | RL Cardigan |
| 9148 | (006) | Skinny Keeper Belt |
| 8157 | (936) | S/L Sequin Tank |
| 3467 | (921) | RL Cardigan |
| 9148 | (006) | Skinny Keeper Belt |

3DOOR | CASUAL 1 STREETWEAR PURSE STAND

- 6082 (957) Nylon Casual Hobo
6082 (006) Nylon Casual Hobo

3DOOR | CASUAL 1 STREETWEAR TABLE

- Purse Riser: (Left):
6069 (198) Denim Pleated Hobo
6767 (197) Jersey Ruffle Scarf
Purse Riser (Right):
6069 (910) Denim Pleated Hobo
767 (092) Jersey Ruffle Hobo
- 6767 (197) Jersey Ruffle Scarf
6069 (198) Denim Pleated Hobo

6069 (910) Denim Pleated Hobo
6767 (092) Jersey Ruffle Hobo
- 6069 (198) Denim Pleated Hobo
7285 (006) Criss Cross Sandal
7285 (002) Criss Cross Sandal
6069 (910) Denim Pleated Hobo

NOTES TO REMEMBER

- This is a 3DOOR table ONLY, stores should refer to 3DOOR MAP on page 4 for location of this table.
- Stores are to place three of each scarf in a circular pattern to create visual interest.

BIRD'S EYE VIEW

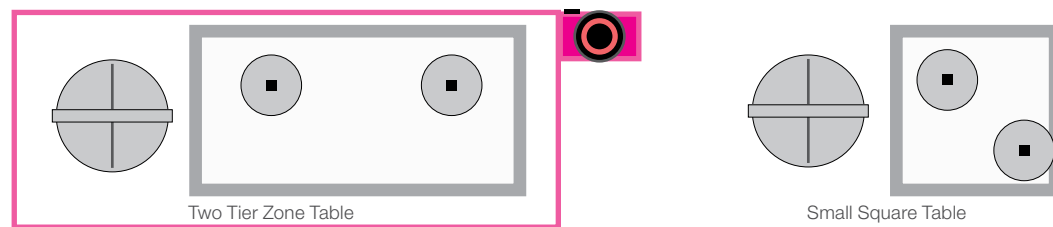
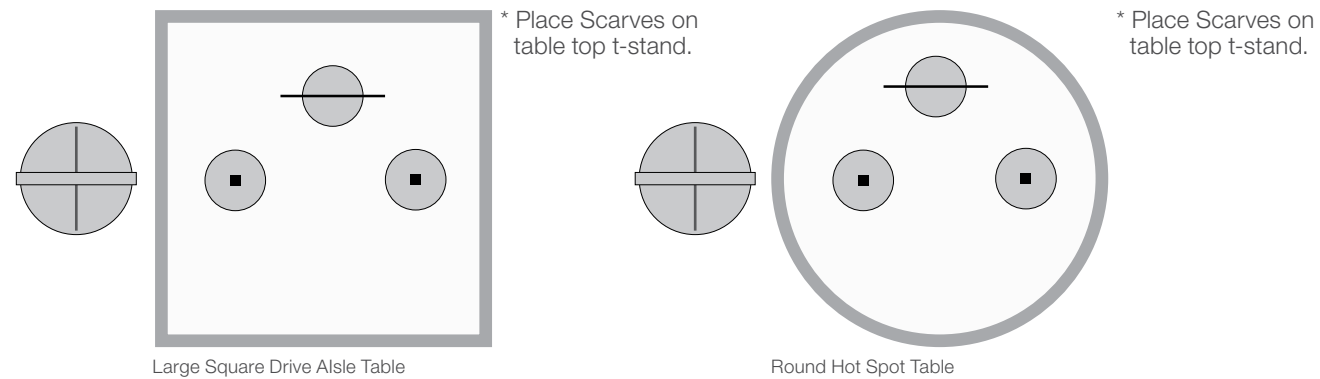

FIXTURE KEY

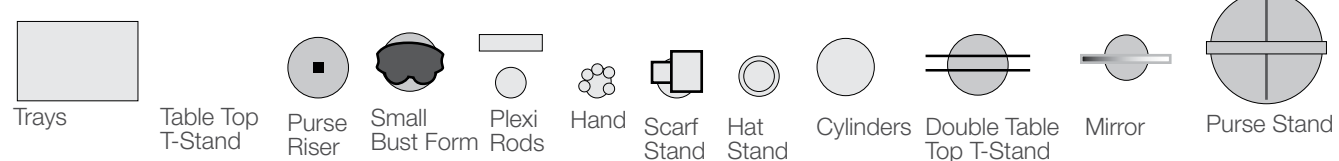

TABLE



FRONT



BELT FIXTURE 1 | FRONT

- | | | | |
|----|------|-------|------------------------|
| 1. | 7032 | (006) | Marrakech Snake Belt |
| | 7032 | (938) | Marrakech Snake Belt |
| | 7062 | (016) | Round Buckle Hook Belt |
| | 7025 | (016) | Laced Grommets Belt |
| | 7025 | (816) | Laced Grommets Belt |
| | 7064 | (898) | Skinny Briad Pullback |
| | 7064 | (901) | Skinny Briad Pullback |
| 2. | 7030 | (816) | Beaded Cording Belt |
| | 7030 | (758) | Beaded Cording Belt |
| | 7030 | (006) | Beaded Cording Belt |
| | 7061 | (001) | Crinkle Snake Stretch |
| | 7034 | (898) | Straw Stretch Belt |
| | 7034 | (298) | Straw Stretch Belt |
| | 7034 | (198) | Straw Stretch Belt |

BACK



BELT FIXTURE 1 | BACK

- | | | | |
|----|------|-------|-------------------------|
| 1. | 7017 | (006) | Studded Skinny Belt |
| | 7017 | (936) | Studded Skinny Belt |
| | 7017 | (833) | Studded Skinny Belt |
| | 9148 | (006) | Skinny Keeper Belt |
| | 9148 | (091) | Skinny Keeper Belt |
| | 7063 | (094) | Reversible PT Belt |
| | 8161 | (006) | Chunky Buckle Logo Belt |
| | 8161 | (898) | Chunky Buckle Logo Belt |
| | 9187 | (006) | Covered Buckle Basic |
| | 9187 | (091) | Covered Buckle Basic |
| | 2990 | (006) | Logo Square Buckle |
| | 2990 | (091) | Logo Square Buckle |
| 2. | 7032 | (006) | Marrakech Snake Belt |
| | 7065 | (901) | Tort Buckle Stretch |
| | 7065 | (006) | Tort Buckle Stretch |
| | 7046 | (006) | All Over Ruffle Stretch |
| | 7059 | (006) | Braid Web Stretch |
| | 7057 | (816) | Braided Front Stretch |
| | 7057 | (006) | Braided Front Stretch |

FRONT



BELT FIXTURE 2 | FRONT

- | | | | |
|----|------|-------|------------------------|
| 1. | 9186 | (006) | Oval Portrait |
| | 9186 | (091) | Oval Portrait |
| | 7001 | (006) | Logo Metal Keeper Belt |
| | 7001 | (898) | Logo Metal Keeper Belt |
| | 9187 | (006) | Covered Buckle Basic |
| | 9187 | (091) | Covered Buckle Basic |
| | 8163 | (006) | Adjust Hook Belt |
| | 8163 | (816) | Adjust Hook Belt |
| | 7062 | (006) | Round Buckle Hook Belt |
| | 7062 | (016) | Round Buckle Hook Belt |
| 2. | 7025 | (016) | Laced Grommets Belt |
| | 7025 | (816) | Laced Grommets Belt |
| | 7051 | (006) | Super Wide |
| | 7052 | (016) | Super Wide |
| | 7051 | (947) | Super Wide |
| | 7048 | (816) | Distressed Stretch |
| | 7048 | (006) | Distressed Stretch |
| | 7048 | (910) | Distressed Stretch |

BACK



BELT FIXTURE 2 | BACK

- | | | | |
|----|------|-------|-----------------------|
| 1. | 7058 | (016) | Single Buckle Perfect |
| | 7058 | (006) | Single Buckle Perfect |
| | 7057 | (816) | Braided Front Stretch |
| | 7026 | (939) | Belted Safari |
| 2. | 7029 | (897) | Python Stretch Belt |
| | 7029 | (006) | Python Stretch Belt |
| | 7029 | (198) | Python Stretch Belt |
| | 7061 | (910) | Crinkle Snake Stretch |
| | 7061 | (198) | Crinkle Snake Stretch |

The following styles can also be housed on this fixture as some of these styles are shown on both fixtures.

- | | | |
|------|-------|-----------------------|
| 7049 | (006) | Multi Ring Stretch |
| 7061 | (006) | Crinkle Snake Stretch |

FRONT



	C1	C2	C3	C4	C5	C6	C7	C8
R1	0364 001 Fishhook Textured Coin	0484 001 Fishhook Dream Catcher Tear	0784 001 Snowman Disc n Hoops	0733 001 Fishhook Scrafted Tear Drop	0783 001 Scrafted Donut	0451 001 Textred Clasp Hoop	0782 897 Diamond Dangle Leavers	
R2	1150 897 Burn Pearl Bubble	9767 897 Sead Bead 4 Row Braid Cuff	9768 897 6 Ball n Filigree Bangles	9770 897 Facet n Pearl Floral Stretch	9769 897 3 Row Ball n Coin Stretch	1153 897 Short Burn Fringe		
R3		9767 897 Sead Bead 4 Row Braid Cuff	9768 897 6 Ball n Filigree Bangles	9789 001 12 Row Textured Bangles	0709 001 Filigree 3 Stone Section Stretch			
R4		1094 897 Long 3 Row Ball Chunk	1093 897 Long 3 Row Natural Beads	1148 897 Long Open Circles	1092 897 Long Filigree Coin Dangle	1152 897 Long Burn Pearl		
R5	1095 897 Medium Many Sead Beads						1091 897 Medium Chain Square Circles Chunk	
R6								
R7								
R8								
R9								

NOTES TO REMEMBER:

- This is the Burnished Metal Jewelry. If stores sell through jewelry they should replace with gold jewelry.

BACK



NOTES TO REMEMBER:

- This is the Full Price Jewelry Fixture.
- Stores should place **FULL PRICE JEWELRY** on this fixture.
- If styles sell through stores should replace with similar size and type of jewelry where possible.

FRONT



	C1	C2	C3	C4	C5	C6	C7	C8
R1	7067 002 Single Pearl Ring	7068 002 Pave Fireball	7069 002 2 Flower Band	0763 002 Stretch Rhinestone	7059 002 Long Square CZ n Pave	7066 002 Swirl n Round Stone		
R2	2204 002 CB Fireballs	2227 002 LB Fireball	2229 002 Post 3 Pearl Button	2226 002 Circle Square Center Button	2225 002 Long Oval Bling Button	2221 002 Swirl Button	2226 002 Circle Square Center Button	
R3	2228 002 Post CZ Teardrop	2207 002 Clutchless CZ Hoop w Slits	2214 002 Mini Flower Hoop	2203 002 Zig Zag CZ Circle Hoop	2213 002 Triple Fire Ball n Pearl	2190 016 LB 2 Pearl Drop	2223 002 CB 5 Strand Cluster	2224 002 Fishhook Bottom Cluster
R4	6113 002 Circle CZ Link	6121 016 Pearl CZ Stretch	6126 002 1 Row CZ Wrap Bracelet	6122 002 Many Rhinestone Stretch	6125 016 Pearl n Stone Shaker	6104 016 2 Row Pearl Stretch	6124 002 Diamond Detail LOR Stretch	
R5	5240 002 Bling Tear Pendant	5243 002 LOR Circle and Tears	4000 002 Comb Pair	4001 002 Bling Comb	5246 016 5 Row Double Side Brooch	5240 002 Bling Tear Pendant		
R6			5247 006 Long Double Brooch n Chain	5244 002 Grey Side Brooch				
R7	5245 002 Heart Pendant Set	5241 002 Tear Drop Statment			5242 016 Pearl Chain Side Brooch	5248 002 Short 1 Row CZ Wrap	5239 002 Round Pave Pendant	
R8								
R9								

NOTES TO REMEMBER:

- Stores have received City Brights marketing and should be placed in the topper marketing as shown.
- Stores should use a 22" fixture WITHOUT the white bottom to house city brights so the topper marketing piece will fit.
- This is the City Brights Fixture.
- Stores should place ONLY City Bright Jewelry on this fixture.
- If styles sell through stores should replace with simliar size and type of jewelry where possible.

BACK



	C1	C2	C3	C4	C5	C6	C7	C8
R1	0768 197 Key Item Snowman	0769 399 Key Item RLM Dangle	0769 899 Key Item RLM Dangle	0769 498 Key Item RLM Dangle	0769 599 Key Item RLM Dangle			
R2	0769 197 Key Item RLM Dangle	0768 399 Key Item Snowman	0768 899 Key Item Snowman	0768 498 Key Item Snowman	0768 599 Key Item Snowman			
R3	1081 197 Key Item Short Ombre Shell	1081 399 Key Item Short Ombre Shell	1081 899 Key Item Short Ombre Shell	1081 498 Key Item Short Ombre Shell	1081 599 Key Item Short Ombre Shell			
R4	1082 197 Key Item Long 4 Row Ribbon Shell	1082 399 Key Item Long 4 Row Ribbon Shell	1082 899 Key Item Long 4 Row Ribbon Shell	1082 498 Key Item Long 4 Row Ribbon Shell	1082 599 Key Item Long 4 Row Ribbon Shell			
R5								
R6								
R7								
R8								
R9								

NOTES TO REMEMBER:

- Stores have received Key Item Shell Jewelry marketing. This should be placed in the topper marketing as shown.
- Stores should use a 22" fixture WITHOUT the white bottom to house city brights so the topper marketing piece will fit.
- This is the Key Item Shell Jewelry Fixture.
- If styles sell through place additional units of the same jewelry shown on the fixture.
- This fixture should remain only Key Item Shell Jewelry.

FRONT



3DOOR | FIXTURE 6 FRONT

- 1. 7280 (922) Knotted Wedge
7290 (922) Knotted Wedge
- 2. 7280 (771) Knotted Wedge
7290 (838) Knotted Wedge
7280 (838) Knotted Wedge
- 3. 7280 (771) Knotted Wedge
7290 (816) Knotted Wedge
7280 (816) Knotted Wedge
- 4. 7250 (939) Strappy Woven Wedge
7250 (899) Strappy Woven Wedge
7250 (899) Strappy Woven Wedge

* This is the Wedge Fixture for 3Doors stores should refer to page 28 for placement of fixture

BACK



3DOOR | FIXTURE 6 BACK

- 1. 7280 (230) Knotted Wedge
7290 (230) Knotted Wedge
- 2. 7280 (059) Knotted Wedge
7290 (838) Knotted Wedge
7280 (838) Knotted Wedge
- 3. 7280 (059) Knotted Wedge
7290 (006) Knotted Wedge
7280 (006) Knotted Wedge
- 4. 7250 (939) Strappy Woven Wedge
7250 (006) Strappy Woven Wedge
7250 (006) Strappy Woven Wedge

* This is the Wedge Fixture for 3Doors stores should refer to page 28 for placement of fixture

3DOOR FIXTURE MAP

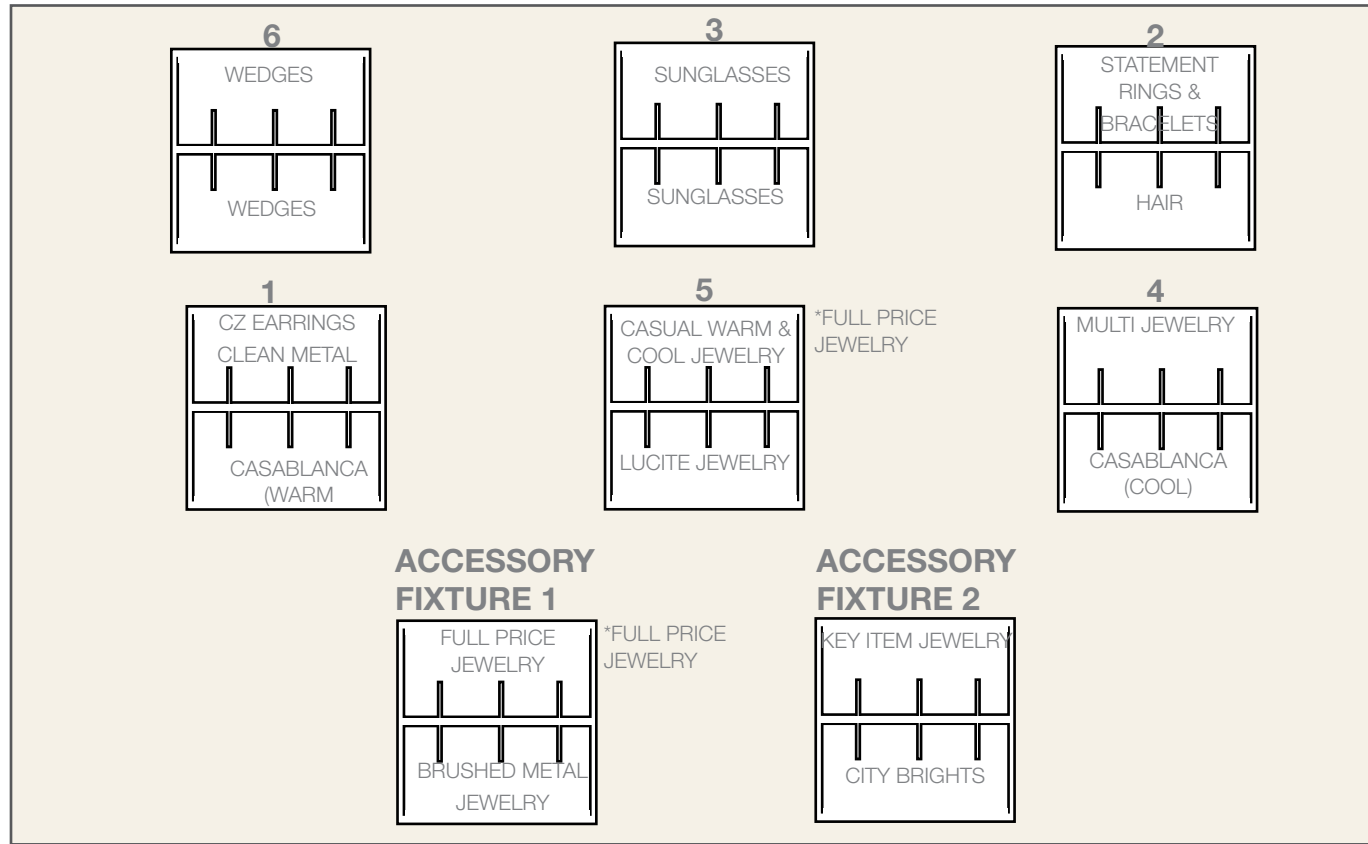

CHAIN FIXTURE MAP

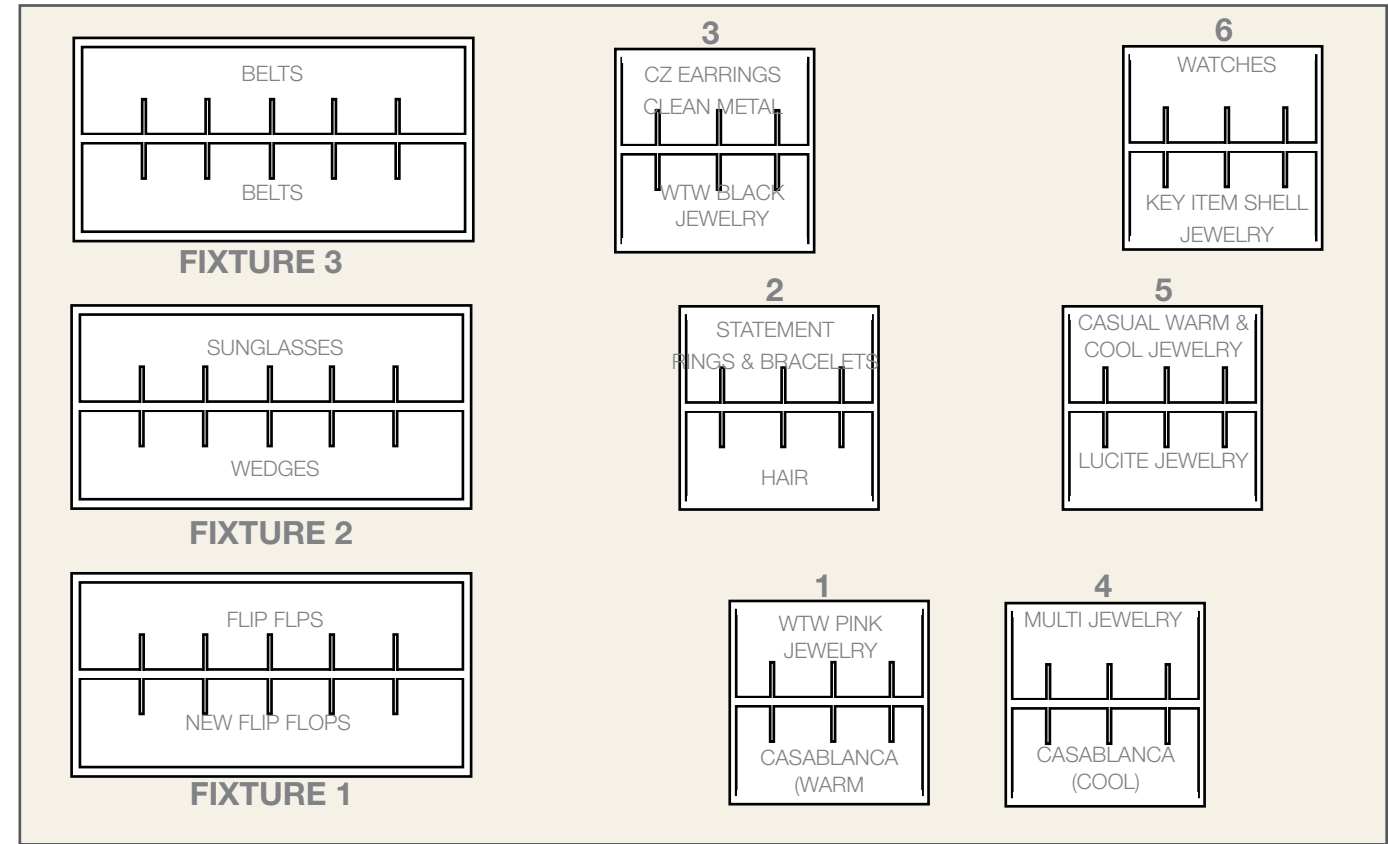

NOTES TO REMEMBER

- Sunglasses Fixture (5): refer to page 44 for new styles to be housed on fixture
- Flip Flop Fixture/Wedges (3): refer to page 42 for visual setup. The Priority styles for flip flops are the Ruffle Flip Flop then the Flower Sandal. The priority for wedges are the Strappy Wedge, then the Key Item Wedge
- All Small Leather Goods should be placed with product.

PROIRITY JEWELRY:

1. Accessory Fixture 1
2. Accessory Fixture 2
3. Fixture 1
4. Fxiture 4
5. Fixture 5
6. Fixture 2
7. Fixture 6
8. Fixture 3

NOTES TO REMEMBER

PROIRITY JEWELRY:

1. Fixture 1
2. Fixture 4
3. Fixture 5
4. Fixture 2
5. Fixture 6
6. Fixture 3

FRONT



	C1	C2	C3	C4	C5	C6	C7	C8
R1	0812 899 Trip Layered Shel w/ Metal	0812 499 Trip Layered Shell w/ Metal	0799 001 Oval Chandelier	0801 699 Circle n Bead Cluster	0797 001 Diamond n Tear Chandelier	0803 699 Trip Swirl Bead	0802 001 Diamond Dangle Tears	
R2	0814 899 Shell Circle With Florals	0814 016 Shell Circle With Florals	0806 897 Double Hoop Gypsy Dangles	0800 699 3 Circle n Beads	0800 898 3 Circle n Beads	0804 001 Oval Diamond Cut Hoop	0813 006 4 Layer Shell Tear Drop	0813 016 4 Layer Shell Tear Drop
R3	9779 699 Swirl Stretch	9787 001 3D Design Hinge	9780 699 5 Row Murano Stretch					
R4	9779 699 Swirl Stretch	9780 699 5 Row Murano Stretch	9788 001 Braided Bead Cuff	9786 899 2 Row Stone Stretch	9781 898 4 Row Nugget Shell Stretch	9787 001 3D Design Hinge	9780 699 5 Row Murano Stretch	
R5	1125 006 2 Row Wood n Shell	1127 699 Short 2 Row Murano	1131 001 5 Row Hammered Pendant	1149 899 Brown Bubbles	1132 699 Red murano Bubbles	1130 699 Short Ethnic 1 Row	1129 899 Short Shell Pendent	
R6	0946 001 Long Shiny Mirror	1133 898 Long 2 Row Beads	1136 699 Long 2 Row Red Murano	1134 699 Red Long 1 Row Chunk	1135 699 Long Ethnic Seed Bead	1128 001 Short 3 Row Metal Tears		
R7								
R8								
R9								

NOTES TO REMEMBER:

- This is the **NEW Casablanca Warm Collection of jewelry.**
- Stores should place red, brown, black and gold jewelry on this fixture
- As styles sell through stores should replace with gold, jewelry from previous deliveries that has remained full price.

BACK



	C1	C2	C3	C4	C5	C6	C7	C8
R1	5812 046 Lucite Flower Stretch	5820 016 Moonstone Daisy Stretch	5815 298 Alice Wonder Top Stretch	5815 298 Alice Wonder Top Stretch				
R2	0786 898 Trip Bead n Circle	0788 298 Shell n Circle Snowman	0729 016 Fishhook Circle Pearl Cluster	0781 298 Fishhook RLM Bead Drop	0731 016 Fishhook 7 Pearl n Circle Chandelier	0787 298 Hoop n Shell	0728 016 Clutchless Pearl Hoop	
R3	9772 898 3 Row Nautral Stretch	9773 298 Coral Beaded Cuff	9771 298 3 Tone Lucite n Bow					
R4	9773 298 Coral Beaded Cuff	9750 002 Matte Metal Stretch	9775 002 Flowers All Around	9772 898 3 Row Nautral Stretch	9771 298 3 Tone Lucite n Bow	9772 898 3 Row Nautral Stretch		
R5	1112 898 Short 2 Row Lucite n Chain	1104 298 Natural/Coral Bubbles	1105 298 Color Lucite Ribbon Tie	1106 898 3 Row Tears	1102 898 Natural Splatter Bead Ribbon	1103 298 Coral Flower Bib		
R6	0983 016 Long Geo Pearl	1110 298 Natural/Coral Long 2 Row Frozen	1107 898 Long Pearl Rhine-Stone n Ribbon	1109 898 Long 2 Row Chunk Flower	1108 898 Long 3-1 Long Starburst Stone	0985 016 Long 5 Row Classic	0992 016 Long Pearl n Chains	
R7								
R8								
R9								

NOTES TO REMEMBER:

- This is the Wear to Work Pink Fixture it is a combination of Lucite, Peach, Pearl and a pop of Coral Jewelry.
- If stores sell through styles place full price pearl, silver or gold jewelry should be used as replacement.

FRONT



	C1	C2	C3	C4	C5	C6	C7	C8
R1	7421 002 Woven Metal Stretch	7421 001 Woven Metal Stretch	7418 001 GD Sequence Twist Wrap	7419 899 Gem Hipster Wrap	7419 006 Gem Hipster Wrap	7422 199 Stone West Stretch		
R2	7424 006 Scroll Jelly Stretch	7424 899 Scroll Jelly Stretch	7423 899 Abstract Beaded Stretch	7407 002 CZ Princess Patch Stretch	7417 006 Layered Black Pearl Stretch	7423 016 Abstract Beaded Stretch	7414 016 2 Row Skinny Pearl Stretch	
R3	7403 006 2 Row Fabric Posey	7420 006 Metal 3 Flower Headband	7403 002 2 Row Fabric Posey					
R4	7402 006 1" Satin Boston Bow	7402 899 1" Satin Boston Bow	7420 006 Metal 3 Flower Headband	7411 002 2 Row Skinny CZ Headebad				
R5								
R6								
R7								
R8								
R9								

NOTES TO REMEMBER:

- This is the Hair Fixture.
- The first two rows should be elastic headbands with the remainder of the fixture being traditional headbands.
- If stores sell through place full price headbands or double represent styles already shown on fixture.

BACK



	C1	C2	C3	C4	C5	C6	C7	C8
R1	5824 002 Greek Bumpy 3 Stacks	5826 002 Stiple Dome	5825 899 Murano Swirl	5822 198 Facet Moon Stone	5822 399 Facet Moon Stone	5819 001 Gold four Stack Bands		
R2	5796 002 Antique Intlek Wave	5714 002 Metal Dome	5805 002 Medium Four Wave Band	5816 006 CZ Loop n Loop	5754 002 Large Loopy	5713 002 Wide Briad	5717 002 Medium Wide Foldover	5794 002 Four Stackable Bands
R3	5705 006 Trip Antique	5790 002 Whimsy Double Flower	5802 006 Epoxy Flower Double Loop	5804 006 Black CZ Butterfly	5788 006 Epoxy Hawaiiin Flower	5808 016 Pearl jangle Ball Cluster	5795 006 5 Holiday Balls	5795 398 5 holiday Balls
R4	9785 299 40 Rolling Solid	9785 399 40 Rolling Solid	9785 001 40 Rolling Solid					
R5	9784 499 30 Row Multi Glitter Bangle	9785 299 40 Rolling Solid	9784 011 30 Row Multi Glitter Bangle	9785 399 40 Rolling Solid	9784 398 30 Row Multi Glitter Bangle			
R6	9784 499 30 Row Multi Glitter Bangle	9784 011 30 Row Multi Glitter Bangle	9784 398 30 Row Multi Glitter Bangle					
R7	9789 002 12 Row Textured Bangles	9789 002 12 Row Textured Bangles	9785 001 40 Rolling Solid	9789 001 12 Row Textured Bangles	9789 001 12 Row Textured Bangles			
R8	9734 016 Pearl Sead Bead Braid Cuff	9751 002 Metal Diamond Hinge	9645 002 Braided Hinge	9719 002 Many Balls	9494 074 Stretch Hammered Circles	9623 071 Multi metal	9494 002 Stretch Hammered Circles	
R9	9762 006 Sead Bead Braid Cuff	0765 006 Epoxy Diamond Hinge	9763 002 Lucite Hinge	9763 016 Lucite Hinge	9522 006 Plastic Hinge	9761 006 Shiny Round Ball	9694 006 Large Fan Hinge	

NOTES TO REMEMBER:

- The Statement Ring and Bracelet Fixture is a combination of Full Price Rings and Full Price Bracelets.
- Stores should use this setup as a color guide if styles have sold through.

FRONT



	C1	C2	C3	C4	C5	C6	C7	C8
R1	0791 006 Epoxy Square Earring	0770 006 Cab Earring	0789 898 Champagne Snowman Pearl	0724 006 Fishhook 3 Flower n 3 Circle	0774 006 Fishhook Brushed Trip	0771 006 Epoxy Geo Trip		
R2	0773 006 Murano Twist Chunk	0727 016 Fishhook Hoop n 9 Pearls	0776 006 Fishhook Foil Teardrop	0772 006 5 Strand Black White Dangle	0729 016 Fishhook Circle Pearl Cluster	0775 006 Trip Saturn	0772 006 5 Strand Black White Dangle	
R3	9761 006 Shiny Round Ball Stretch	9763 002 Lucite Hinge	9763 016 Lucite Hinge	9730 006 Flower w/ CZ Hinge	9694 006 Large Fan HInge	9765 006 Epoxy Diamond Hinge	9762 006 Seed Bead Braid Cuff	9764 006 3 Row Foiled Stretch
R4	1084 006 Short Cab Bib	1087 006 Short Geo Epoxy	1113 006 Short Lucite n Black Flower	1083 006 Foil Bubbles	1089 006 Short Foil Egg Ribbon	1115 006 Epoxy Square Pendant		
R5	0937 016 Long Chain Pearl Brush Ball	0910 006 Long Zebra n Crinkle Bead	1085 006 Long Foil Frozen 1 Row	1086 006 Long Geo Epoxy	1088 006 Long Murano Dangle	0983 016 Long Geo Pearl	1090 006 60" Pearl	
R6								
R7								
R8								
R9								

NOTES TO REMEMBER:

- This is the **Black and White Collection** of jewelry.
- Stores should place only black, and white jewelry on this fixture.
- As styles sell through stores should replace with silver, pearl or black jewelry from previous deliveries that has remained full price.

SUMMER 2010 • **Fixture 3** • CZ & Metal Earrings

BACK

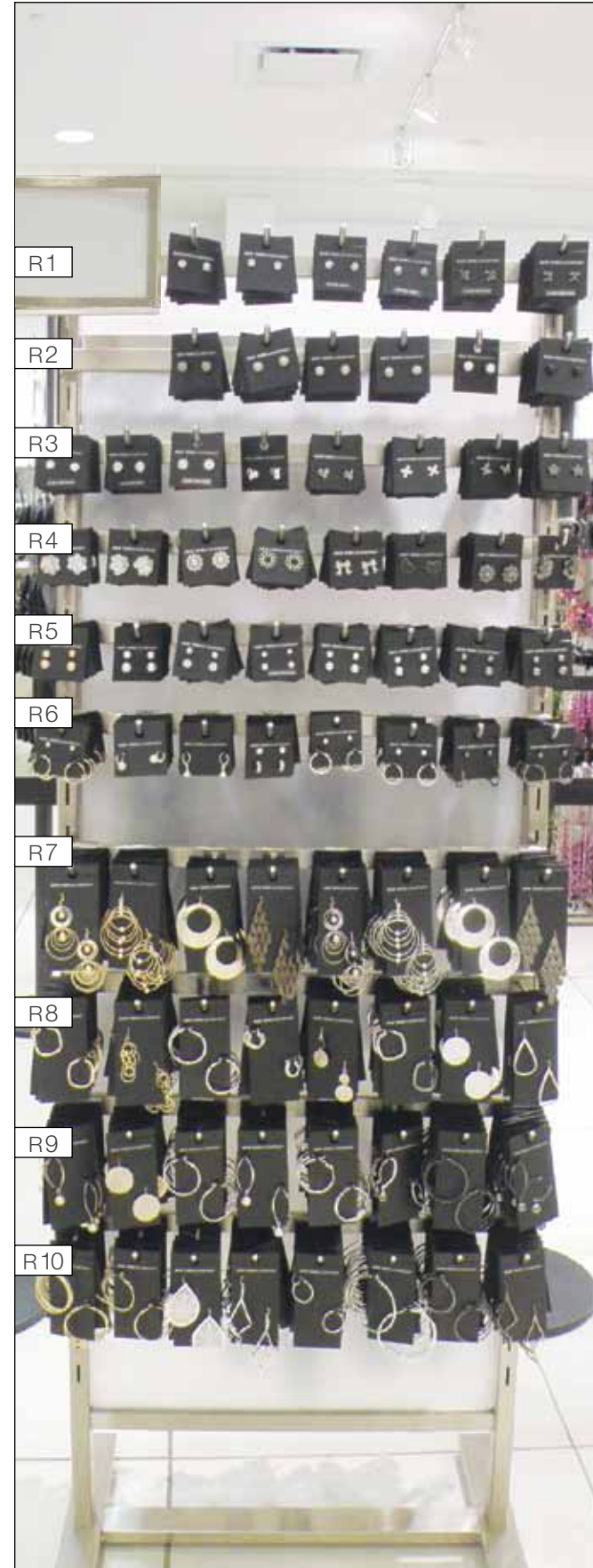

	C1	C2	C3	C4	C5	C6	C7	C8
R1	0992 002 AB Disco Ball	0922 002 AB Disco Ball	0978 002 Post AB Cube	0978 002 Post AB Cube	0850 006 Post Square Opaque Stone	0850 006 Post Square Opaque Stone		
R2	0719 046 Post Fireball	0719 046 Post Fireball	0793 002 Stippled Ball Post	0793 002 Stippled Ball Post	0859 016 Pearl Earring	0777 006 Post Round Ball		
R3	0971 002 Round CZ	0862 002 Post Round Pave Edge	0862 002 Post Round Pave Edge	0762 002 Post Pyramid Heart	0762 074 Post Pyramid Heart	0957 002 CZ X	0997 074 Black Diamond Butterfly	0999 074 Black Diamond Star
R4	0808 898 Shell Petaled Flower	0808 898 Shell Petaled Flower	0760 016 Post Small Button	0760 016 Post Small Button	0761 006 Post Small Button	0991 002 Post Crystal bow	0995 074 Post Cry heart	0998 074 Black Diamond Button
R5	0966 001 Duo Post Ball	0961 016 Pearl Earring	0962 002 Fireball Duo	0960 002 Square CZ Duo	0966 002 Duo Post Ball	0966 002 Duo Post Ball	0966 074 Duo Post Ball	0966 074 Duo Post Ball
R6	0895 001 Post Ball n Hoop	0968 002	0857 002 LB Metal Ball	0861 002 Duo Post CZ Small CZ Hoop	0895 002 Post Ball Hoop	0895 002 Post Ball n Hoop	0895 074 Post Ball n Hoop	0895 074 Post Ball n Hoop
R7	0784 001 Snowman Disc n Hoops	0785 001 5 Hoop n Balls	0783 001 Scratched Donut	0782 001 Diamond Dangle Leaves	0784 002 Snowman Disc n Hoops	0785 002 5 Hoops n Balls	0783 002 Scratched Donut	0782 002 Diamond Dangle Leaves
R8								
R9								
R10								

NOTES TO REMEMBER:

- This is the Look Of Real, and Clean Metal Earring Fixture.
- Rows 1-5 should be small carded earrings.
- ROWS 9-11 stores should place full price silver, CZ and gold large earrings
- If stores sell through styles replace with full price earrings of similar size, and color.

FRONT



	C1	C2	C3	C4	C5	C6	C7	C8
R1	0812 399 Trip Layered Shell w/ Metal	0812 197 Trip Layered Shell w/ Metal	0809 002 Double Hoop Snowman	0801 398 Circle n Bead Cluster	0807 398 Multi Strand Dangle			
R2	0814 399 Shell Circle With Florals	0814 197 Shell Circle With Florals	0800 398 3 Circle n Beads	0804 002 Oval Diamond Dangle Tears	0813 197 4 Layer Shell Teardrop	0813 399 4 Layer Shell Teardrop	0802 002 Diamond Dangle Tears	
R3	9781 398 4 Row Nugget	9787 002 3D Design	9779 399 Swirl Stretch					
R4	9786 197 2 Row Stone Stretch	9786 399 2 Row Stone Stretch	9788 002 Braided Bead Cuff	9781 398 4 Row Nugget	9782 398 2 Row Large Bead Stretch	9787 002 3D Design	9779 398 Swirl Stretch	
R5	1131 002 5 Row Hammered Pendant	1127 398 Short 2 Row Murano	1130 398 Short Ethnic 1 Row	1139 398 Blue Green Bubbles	0944 002 Short Boxes Bubbles	1138 398 Chunky Caterpillar	1129 398 Short Shell Pendant	
R6	1133 197 Long 2 Row Beads	1142 398 Long Blue Green 1 Row Chunk	1140 398 Long Blue Green Dangle	1135 398 Long Ethnic Sead Bead	1133 399 Long 2 Row Beads	1128 002 Short 3 Row Metal Tears		
R7								
R8								
R9								

NOTES TO REMEMBER:

- This is the **NEW Casablanca Cool Collection** of jewelry.
- Stores should place green, blue, and silver jewelry on this fixture
- As styles sell through stores should replace with silver, jewelry from previous deliveries that has remained full price.

BACK



	C1	C2	C3	C4	C5	C6	C7	C8
R1	1147 699 Long Knotted Seed Bead	1147 797 Long Knotted Seed Bead	1147 399 Long Knotted Seed Bead	1147 197 Long Knotted Seed Bead	1147 899 Long Knotted Seed Bead	1147 006 Long Knotted Seed Bead		
R2	0810 011 Small Dangle Cluster	0811 011 Hoop n Bead Cluster	9783 011 3 Row Large Bead Stretch	9784 011 30 Row Multi Glitter Bangle	9783 011 3 Row Large Bead Stretch	0801 011 Circle n Bead Cluster	0800 011 3 Circle n Beads	
R3	1138 011 Chunky Caterpillar	1155 011 Many Multi Strands	1143 011 Long Color Block Multi	1146 011 Long Multi Dangles	1144 011 Long Multi n Coins	1155 011 Many Multi Strands	1145 011 Multi Bubbles	
R4								
R5								
R6								
R7								
R8								
R9								

NOTES TO REMEMBER:

- This is the **NEW Multi Collection** of jewelry.
- Stores should place multi colored jewelry on this fixture
- As styles sell through stores should replace with silver, jewelry from previous deliveries that has remained full price.

FRONT



	C1	C2	C3	C4	C5	C6	C7	C8
R1	5823 002 Oval Antique	5824 002 Greek Bumpy 3 Stacks	5826 002 Stiple Dome	5821 046 Lucite Flower Stretch	5820 016 Moonstone Daisy Stretch			
R2	0795 074 Trip Faceted Crystal Drop	0792 074 Faceted Smoky Teardrop	0796 074 Crystal Snowman	0796 046 Crystal Snowman	0797 046 Dimoand n Tear Chandelier	0799 046 Oval Chandelier	0806 002 Double Hoop Gypsy Dangles	0794 046 Moonstone Cab Tear
R3	9776 046 Multi Bead Stretch	9777 046 Silver Beaded Cuff	0764 006 3 Row Folied Stretch	9788 002 Braided Bead Cuff	9763 002 Lucite Hinge	9778 074 Lucite Stretch		
R4	1117 046 Wilma w Bow	1116 046 5 Row Clear Bubbles	1118 074 Short 2 Row Lucite	1120 046 Ribbon n Side Dangles	1118 046 Short 2 Row Lucite	1084 006 Short Cag Bib	1119 046 Short Baubles n Ribbon Weave	
R5	1124 046 Long 1 Row Frozen	1123 046 Long 3 Row Chunky	1121 074 Long 1 Row Lucite	1122 046 Long Clear Stone n Tassel	1121 046 Long 1 Row Lucite	1107 046 Long Pearl Rhinestone n Ribbon	1154 046 Long Pearl Metal Layers	
R6								
R7								
R8								
R9								

NOTES TO REMEMBER:

- This is the NEW Lucite Collection of jewelry.
- Stores should place only lucite jewelry on this fixture
- As styles sell through stores should replace with silver, jewelry from previous deliveries that has remained full price.

BACK



	C1	C2	C3	C4	C5	C6	C7	C8
R1	0779 397 Trip Hoop n Tear Drop	0778 397 Multi Bead Cluster	0779 597 Trip Hoop n Tear Drop	0778 597 Multi Bead Cluster				
R2	0791 397 Epoxy Square Earring	0791 198 Epoxy Square Earring	0779 397 Trip Hoop n Tear Drop	0781 397 Fishhook RLM Bead Drop	0780 397 5 Strand Multi Dangle	0781 597 Fishhook RLM Bead Drop	0780 597 5 Strand Mlti Dangle	
R3	9766 397 Casual 3 Row	9765 397 Epoxy Diamond Hinge	9766 397 Casual 3 Row	9766 597 Casual 3 Row	9765 597 Epoxy Diamond Hinge	9766 597 Casual 3 Row		
R4	1115 198 Epoxy Square Pendant	1115 397 Epoxy Square Pendant	1096 397 Casual Potato Bubbles	1098 397 Casual Side Brooch	1098 597 Casual Side Brooch	1098 597 Casual Side Brooch	1096 597 Casual Potato Bubbles	
R5	1097 397 Casual Medium Chunk Arts	1100 397 Casual Long Potato Chip	1100 397 Casual Long Potato Chip	1101 397 Long 2 Loopy Beefy	1101 597 Long 2 Lopyy Beefy	1100 597 Casual Long Potato Chip	1096 597 Casual Potato Bubbles	
R6								
R7								
R8								
R9								

NOTES TO REMEMBER:

- This is the **Boy Meets Girl - Casual Fixture**. It is a combination of Cool and Warm Jewelry story.
- If styles sell through place full jewelry.

FRONT



	C1	C2	C3	C4	C5	C6	C7	C8
R1	0768 399 Key Item Snowman	0768 899 Key Item Snowman	0768 899 Key Item Snowman	0768 498 Key Item Snowman	0768 599 Key Item Snowman			
R2	0768 197 Key Item Snowman	0769 197 Key Item RLM Dangle	0769 399 Key Item RLM Dangle	0769 899 Key Item RLM Dangle	0769 899 Key Item RLM Dangle	0769 498 Key Item RLM Dangle	0769 599 Key Item RLM Dangle	
R3	9760 197 Key Item Shell Stretch	9760 399 Key Item Shell Stretch	9760 899 Key Item Shell Stretch	9760 498 Key Item Shell Stretch	9760 599 Key Item Shell Stretch			
R4	9760 197 Key Item Shell Stretch	9760 399 Key Item Shell Stretch	9760 899 Key Item Shell Stretch	9760 899 Key Item Shell Stretch	9760 498 Key Item Shell Stretch	9760 599 Key Item Shell Stretch		
R5	1081 197 Key Item Short Ombre Shell	1081 399 Key Item Short Ombre Shell	1081 899 Key Item Short Ombre Shell	1081 899 Key Item Short Ombre Shell	1081 498 Key Item Short Ombre Shell	1081 599 Key Item Short Ombre Shell		
R6	1082 197 Key Item Long 4 Row Ribbon	1082 399 Key Item Long 4 Row Ribbon	1082 899 Key Item Long 4 Row Ribbon	1082 899 Key Item Long 4 Row Ribbon	1082 498 Key Item Long 4 Row Ribbon	1082 599 Key Item Long 4 Row Ribbon		
R7								
R8								
R9								

- NOTES TO REMEMBER:**
- This is the Key Item Shell Jewelry Fixture.
 - If styles sell through place additional units of the same jewelry shown on the fixture.
 - This fixture should remain only Key Item Jewelry.

BACK



	C1	C2	C3	C4	C5	C6	C7	C8
R1	7247 898 Shell Stretch	7247 898 Shell Stretch	7247 198 Shell Stretch	7247 198 Shell Stretch	7247 899 Shell Stretch	7247 899 Shell Stretch		
R2	7249 001 Oval Antique Stretch	7249 001 Oval Antique Stretch	7249 002 Oval Antique Stretch	7249 001 Oval Antique Stretch	7248 198 Arizona Statement Hinge	7248 198 Arizona Statement Hinge	7227 016 Wide Stretch Pearl	7227 016 Wide Stretch Pearl
R3	7240 006 Cermic Hinge	7240 006 Cermic Hinge	7240 016 Cermic Hinge	7240 016 Cermic Hinge	7246 016 Smooth In Motion	7246 016 Smooth In Motion	7210 002 Skinny Circle Link	7210 002 Skinny Circle Link
R4	7224 001 Key n Heart Link	7224 001 Key n Heart Link	7250 899 Oval Bracelet Link	7130 002 Many Circles	7175 002 Pave O Link	7224 002 Key n Heart Link	7224 002 Key n Heart Link	7243 016 Round Pave Softie
R5	7234 001 Many Metal Link	7234 001 Many Metal Link	7163 001 Square Vintage	7163 001 Square Vintage	7163 002 Square Vintage	7163 002 Square Vintage	7234 002 Many Metal Link	7234 002 Many Metal Link
R6								
R7								
R8								
R9								

NOTES TO REMEMBER:

- This is the Watch Fixture. Stores should place only full price watches on this fixture.
- If styles sell through stores should replace with a similar size, face shape, and color where possible.

WRAP DESK: PAGES 44



DRIVE AISLE: PAGES 42-43

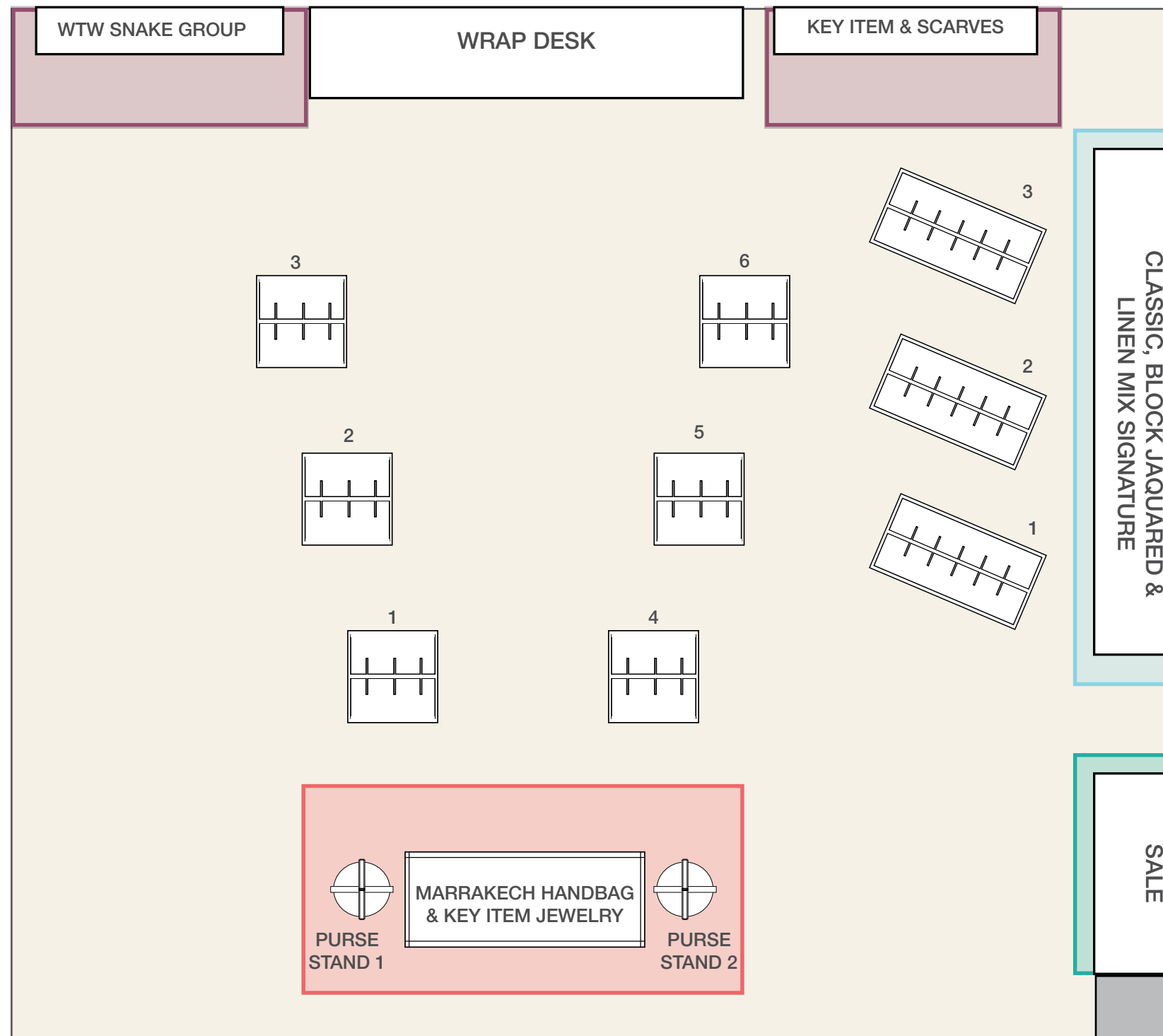

LARGE WALL: PAGES 45



LARGE WALL: PAGES 46



NOTE: Store should house all Wristlets and Wallets with corresponding collections as there is no longer a designated Wristlet and Wallet Fixture. Stores should note the addition of a Wristlet and Wallet Section in the Large Wall on page 45 for any additional Wristlets and Wallets that needed housing.

CHAIN | DRIVE AISLE TABLE

1. Double Table Top T-Stand:

- Row 1:
 9760 (899) Key Item Shell Stretch
 9769 (197) Key Item Shell Stretch

- Row 2:
 1082 (899) Key Item Long 4 Row Ribbon
 1082 (197) Key Item Long 4 Row Ribbon

- Purse Riser (Left Front):
 6223 (198) Marrakech Snake Satchel
 6257 (198) Marrakech Snake Wristlet

- Purse Riser (Middle):
 6223 (938) Marrakech Snake Satchel
 6257 (938) Marrakech Snake Wristlet

- Purse Riser (Right Back):
 6223 (006) Marrakech Snake Satchel
 6257 (006) Marrakech Snake Wristlet

2. Tray:
 6257 (198) Marrakech Snake Wristlet
 6257 (298) Marrakech Snake Wristlet
 6257 (006) Marrakech Snake Wristlet
 6257 (938) Marrakech Snake Wristlet

3. Bottom of Table:
 6223 (198) Marrakech Snake Satchel
 6223 (006) Marrakech Snake Satchel
 6223 (938) Marrakech Snake Satchel
 6223 (298) Marrakech Snake Satchel

BIRD'S EYE VIEW

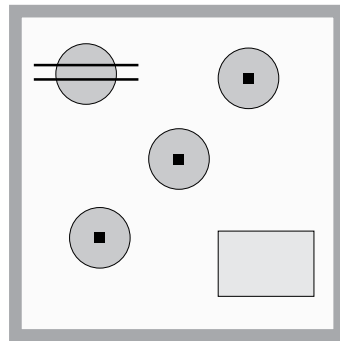

Large Square Drive Aisle Table

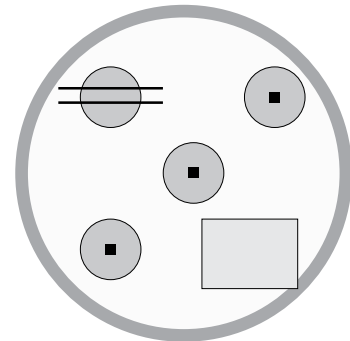

Round Hot Spot Table

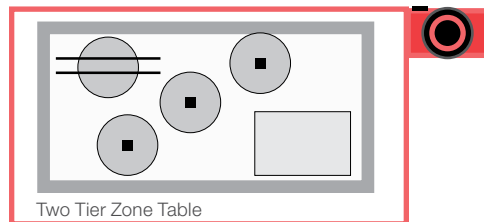

Two Tier Zone Table

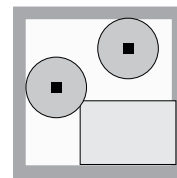

Small Square Table

FIXTURE KEY

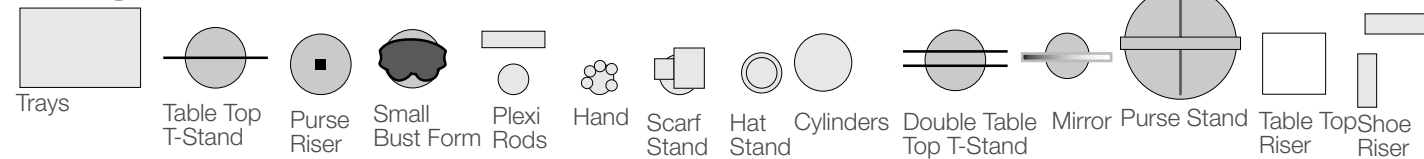

TABLE

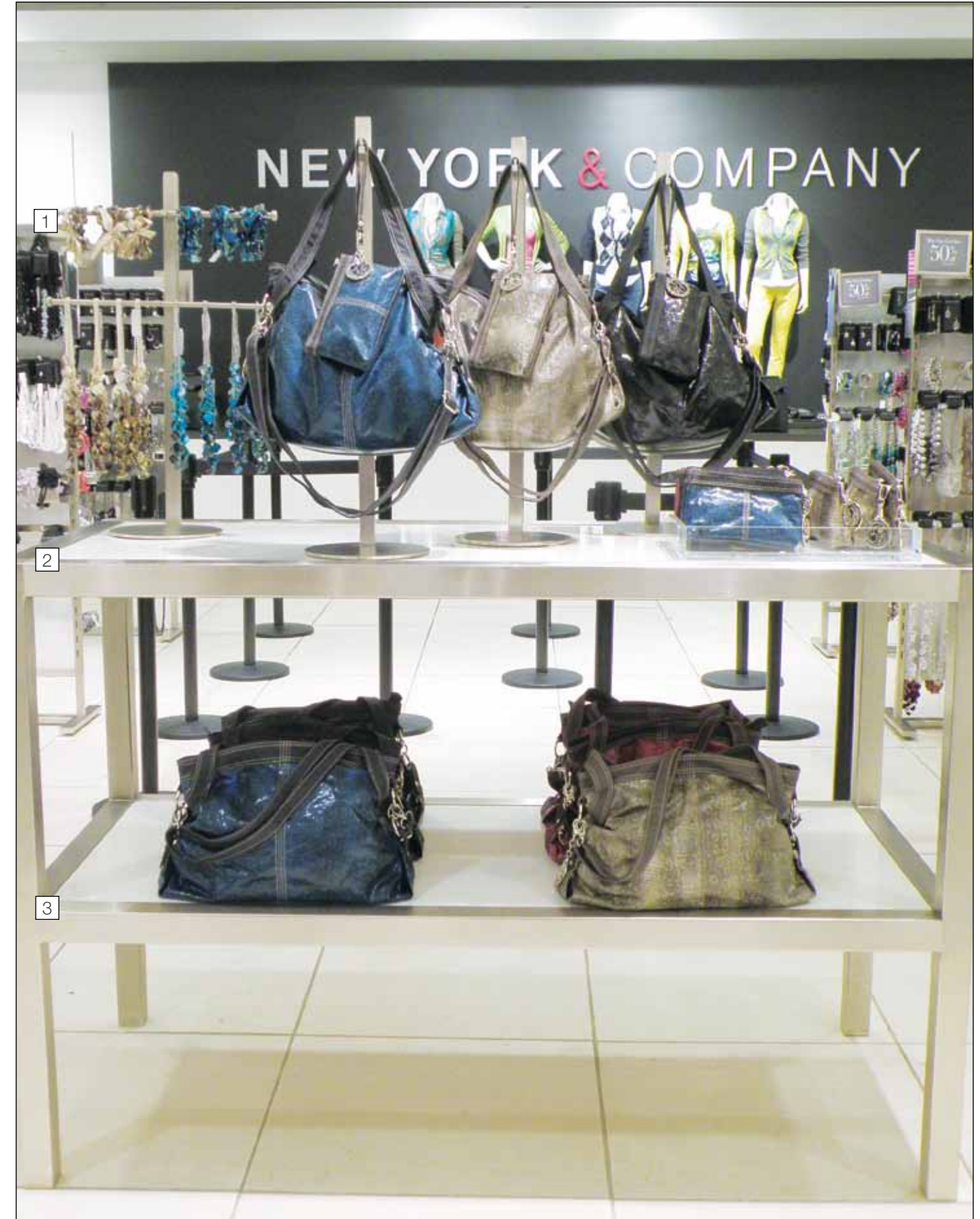

PURSE STAND 1



CHAIN | PURSE STAND 1

- | | | |
|---------|-------|--------------|
| 1. 6085 | (197) | Slouchy Tote |
| 6085 | (939) | Slouchy Tote |
| 2. 6085 | (006) | Slouchy Tote |
| 6085 | (816) | Slouchy Tote |

PURSE STAND 2



CHAIN | PURSE STAND 2

- | | | |
|---------|-------|---------------------|
| 1. 6090 | (016) | Hammered Stud XBody |
| 6090 | (898) | Hammered Stud XBody |
| 6090 | (006) | Hammered Stud XBody |
| 2. 6268 | (016) | Hammered Stud Tote |
| 6268 | (898) | Hammered Stud Tote |
| 6268 | (006) | Hammered Stud Tote |

WRAP DESK LEFT



CHAIN WRAP DESK LEFT

- | | | | |
|----|------|-------|-----------------|
| 1. | 3011 | (198) | Python Hobo |
| | 6736 | (726) | Banded Fedora |
| | 6793 | (134) | Raven Reptile |
| 2. | 6113 | (897) | Python XBody |
| | 6793 | (804) | Raven Reptile |
| | 6229 | (897) | Python Wristlet |
| 3. | 3011 | (897) | Python Hobo |
| 4. | 6113 | (006) | Python XBody |
| | 6113 | (198) | Python XBody |
| | 6229 | (198) | Python Wristlet |
| 5. | 3011 | (198) | Python Hobo |
| | 6793 | (134) | Raven Reptile |
| 6. | 3011 | (006) | Python Hobo |
| | 6229 | (006) | Python Wristlet |

The Python Hobo and Crossbody in Black are Accessry Store only and should be replaced with the Light Brown for stores that do not receive them.

WRAP DESK RIGHT



CHAIN WRAP DESK RIGHT

- | | | | |
|----|------|-------|------------------------|
| 1. | 6271 | (230) | Key Item Hardware Tote |
| | 6798 | (011) | Multi Butterfly Scarf |
| 2. | 6271 | (230) | Key Item Hardware Tote |
| | 6271 | (016) | Key Item Hardware Tote |
| | 6271 | (347) | Key Item Hardware Tote |
| 3. | 6751 | (016) | Battenburg Lace |
| | 6798 | (011) | Multi Butterfly Scarf |
| | 6857 | (406) | Pastel Open Weave |
| | 6822 | (290) | Quirkly Ombre Scarf |
| | 6751 | (290) | Battenburg Lace |
| | 6820 | (597) | Purple Multi Nubby |
| | 6822 | (347) | Ouriky Ombre Scarf |
| | 6751 | (347) | Battenburg Lace |
| | 6799 | (011) | Easter Egg Scarf |
| | 6821 | (898) | Bandini Scarf |
| | 6858 | (011) | Milky Way |
| | 6825 | (804) | Beaded Natural |
| | 6271 | (006) | Key Item Hardware Tote |
| 4. | 6271 | (847) | Key Item Hardware Tote |

CHAIN LARGE WALL CABINET 1 CABINET 1

- 1. 7250 (899) Strappy Woven Wedge
- 7689 (091) Scribbles Metal Clip Bag
- 2. 7580 (091) Scribbles Big Buckle Tote
- 8206 (091) Belted Hardware Demi
- 6320 (091) Scribble Foldover Tote
- 3. 7286 (091) Script Turnlock
- 7689 (091) Scribbles Metal Clip Bag
- 4. 6233 (897) Linen Mix Hobo
- 6252 (897) Linen Mix Wristlet
- 7579 (091) Scribbles Big Buckle Satchel
- 8044 (091) Logo Script Center Cross Body
- 5. 8130 (091) Side Drawstring Satchel

NOTE:
3Doors are to add 6248 (091) Applique Flower Hobo to Cabinet 1

CHAIN LARGE WALL CABINET 2

- 1. 6179 (897) Block Jaquared Tote
- 6180 (897) Block Jaquared Hobo
- 6149 (897) Block Jacquard Wallet
- 2. 6180 (897) Block Jaquared Hobo
- 6180 (006) Block Jaquared Hobo
- 3. 6179 (897) Block Jaquared Tote
- 6179 (006) Block Jaquared Tote
- 4. 6134 (898) Pieced Tile Wristlet
- 8162 (091) Script Pushlock Coin
- 7663 (091) Scribbles Wristlet
- 6134 (006) Pieced Tile Wristlet
- 8162 (006) Script Pushlock Coin
- 7663 (965) Scribbles Wristlet
- 5. 6149 (006) Block Jaquared Wallet
- 6149 (897) Block Jaquared Wallet
- 6279 (898) Pieced Tile Wallet
- 6279 (006) Pieced Tile Wallet
- 6105 (006) Hammered Stud Wallet
- 6105 (016) Hammered Stud Wallet
- 6105 (898) Hammered Stud Wallet
- 6103 (006) Safari Envelope
- 6103 (939) Safari Envelope
- 6103 (347) Safari Envelope
- 6103 (816) Safari Envelope
- 7662 (091) Scribbles Signature Wallet
- 7662 (965) Scribbles Signature Wallet
- 6224 (091) Scribbles Buckle Wallet
- 6224 (965) Scribbles Buckle Wallet

CHAIN LARGE WALL CABINET 3

- 1. 7689 (965) Scribbles Metal Clip Bag
- 7250 (006) Strappy Woven Wedge
- 2. 6320 (965) Scribble Foldover Tote
- 8206 (006) Belted Hardware Demi
- 7580 (965) Scribbles Big Buckle Tote
- 3. 7286 (006) Script Turnlock
- 7689 (965) Scribbles Metal Clip Bag
- 4. 7579 (965) Scribbles Big Buckle Satchel
- 8044 (006) Logo Script Center Cross Body
- 6252 (006) Linen Mix Wristlet
- 6233 (006) Linen Mix Hobo
- 5. 8130 (006) Side Drawstring Satchel

NOTE:
3Doors are to add 6248 (006) Applique Flower Hobo to Cabinet 1

CABINET 2

CABINET 3



SUMMER 2010 • Chain Sale Wall

CHAIN | APPAREL SALE WALL

STORES ARE TO PLACE ALL SALE ACCESSORY IN APPAREL SALE ZONE.

STORES SHOULD USE THIS SETUP AS A VISUAL GUIDE

CABINET 1

CABINET 2

CABINET 3



FRONT



CHAIN 44" FIXTURE 1

- | | | | | |
|----|------------|-------------------------|------------|-----------------------|
| 1. | 7259 (898) | Patchwork Flip Flop | 7258 (298) | Straw Crossover Wedge |
| | 7259 (006) | Patchwork Flip Flop | 7258 (298) | Straw Crossover Wedge |
| | 7285 (006) | Criss Cross Sandal (2x) | | |
| | 7285 (002) | Criss Cross Sandal | | |
| 2. | 7294 (198) | Round Bead Sandal | | |
| | 7294 (698) | Round Bead Sandal | | |
| | 7295 (006) | Bugle Bead T-Strap | | |
| | 7282 (006) | Horseshoe Sandal | | |
| | 7282 (898) | Horseshoe Sandal | | |
| | 7289 (898) | Double Strap Bead | | |
| 3. | 7294 (198) | Round Bead Sandal | | |
| | 7294 (698) | Round Bead Sandal | | |
| | 7295 (006) | Bugle Bead T-Strap | | |
| | 7282 (006) | Horseshoe Sandal | | |
| | 7282 (898) | Horseshoe Sandal | | |
| | 7289 (898) | Double Strap Bead | | |
| 4. | 7258 (198) | Straw Crossover Wedge | | |
| | 7258 (198) | Straw Crossover Wedge | | |
| | 7258 (898) | Straw Crossover Wedge | | |
| | 7258 (898) | Straw Crossover Wedge | | |

BACK



CHAIN 44" FIXTURE 1

- | | | | | |
|----|------------|-------------------------|--|--|
| 1. | 7281 (770) | Ombre Flower Sandal | | |
| | 7281 (011) | Ombre Flower Sandal | | |
| | 7281 (896) | Ombre Flower Sandal | | |
| | 7281 (006) | Ombre Flower Sandal | | |
| 2. | 7281 (230) | Ombre Flower Sandal | | |
| | 7281 (347) | Ombre Flower Sandal | | |
| | 7281 (965) | Ombre Flower Sandal | | |
| | 7281 (896) | Ombre Flower Sandal | | |
| | 7281 (006) | Ombre Flower Sandal | | |
| 3. | 7279 (001) | Double Ruffle Flip Flop | | |
| | 7279 (016) | Double Ruffle Flip Flop | | |
| | 7279 (002) | Double Ruffle Flip Flop | | |
| | 7279 (006) | Double Ruffle Flip Flop | | |
| 4. | 7279 (290) | Double Ruffle Flip Flop | | |
| | 7279 (347) | Double Ruffle Flip Flop | | |
| | 7279 (896) | Double Ruffle Flip Flop | | |
| | 7279 (965) | Double Ruffle Flip Flop | | |
| | 7279 (006) | Double Ruffle Flip Flop | | |

FRONT



CHAIN | 44" FIXTURE 2

1. 7280 (922) Knotted Wedge	3. 7280 (230) Knotted Wedge
7280 (922) Knotted Wedge	7280 (230) Knotted Wedge
7280 (922) Knotted Wedge	7280 (059) Knotted Wedge
7280 (059) Knotted Wedge	7280 (059) Knotted Wedge
7280 (059) Knotted Wedge	7280 (006) Knotted Wedge
2. 7280 (771) Knotted Wedge	7280 (006) Knotted Wedge
7280 (771) Knotted Wedge	4. 7250 (939) Strappy Woven Wedge
7280 (816) Knotted Wedge	7250 (939) Strappy Woven Wedge
7280 (816) Knotted Wedge	7250 (899) Strappy Woven Wedge
7280 (838) Knotted Wedge	7250 (899) Strappy Woven Wedge
7280 (838) Knotted Wedge	7250 (006) Strappy Woven Wedge
	7250 (006) Strappy Woven Wedge

BACK

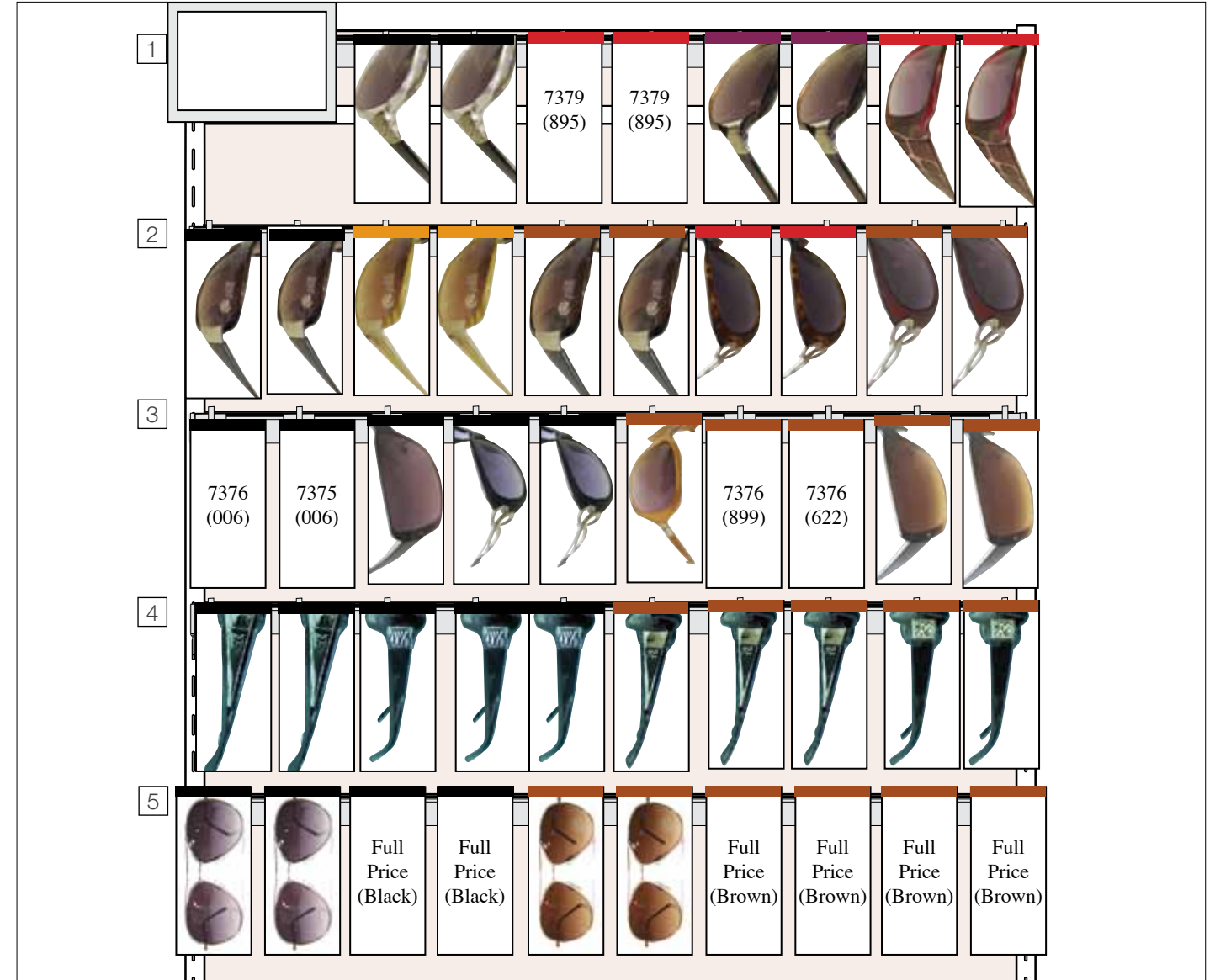

CHAIN | 44" FIXTURE 3

1. 7379 (010) Glam Rocker (2x)
7379 (895) Glam Rocker (2x)
7379 (599) Glam Rocker (2x)
8306 (622) Etched Croc
2. 7380 (006) Paparazzi Blocker (2x)
7380 (032) Paparazzi Blocker (2x)
7380 (895) Paparazzi Blocker (2x)
7377 (895) Jubilee (2x)
7377 (699) Jubilee (2x)
3. 7376 (006) Flower Logo (2x)
7375 (006) Kristen
7377 (006) Jubilee (2x)
7375 (917) Kiersten
7375 (899) Kristen
7376 (006) Flower Logo
7375 (622) Kristen
7375 (895) Kristen
4. 8343 (006) Metal Logo (2x)
8344 (006) Charade (2x)
8343 (895) Metal Logo (3x)
8344 (899) Charade (2x)

5 Place Full Price Styles of sunglasses grouped together by style.

FRONT



CHAIN 44" FIXTURE 3

- 1. 7034 (198) Straw Stretch Belt
- 7034 (298) Straw Stretch Belt
- 7034 (898) Straw Stretch Belt
- 7032 (006) Marrakech Snake Belt
- 7032 (938) Marrakech Snake Belt
- 7064 (901) Skinny Briad Pullback
- 7064 (898) Skinny Briad Pullback
- 7065 (006) Tort Buckle Stretch
- 7065 (901) Tort Buckle Stretch
- 7063 (094) Reversible Pt Belt
- 7030 (816) Beaded Cording Belt
- 7030 (758) Beaded Cording Belt
- 7030 (006) Beaded Cording Belt

BACK



CHAIN 44" FIXTURE 3

- | | |
|------------------------------------|-------------------------------------|
| 1. 7017 (006) Studded Skinny Belt | 7062 (016) Round Buckle Hook Belt |
| 7017 (936) Studded Skinny Bet | 7062 (006) Round Buckle Hook Belt |
| 9148 (006) Skinny Keeper Belt | 2. 7061 (001) Crinkle Snake Stretch |
| 9148 (091) Skinny Keeper Belt | 7061 (198) Crinkle Snake Stretch |
| 7001 (006) Logo Metal Keeper Belt | 7061 (910) Crinkle Snake Stretch |
| 7001 (898) Logo Metal Keeper Belt | 7061 (006) Crinkle Snake Stretch |
| 8161 (006) Chunky Buckle Logo Belt | 7029 (198) Pyton Stretch Belt |
| 8161 (091) Chunky Buckle Logo Belt | 7029 (897) Pyton Stretch Belt |
| 9187 (006) Covered Buckle Basic | 7058 (016) Single Buckle Perfect |
| 9187 (091) Covered Buckle Basic | 7058 (006) Single Buckle Perfect |
| 9186 (006) Oval Portrait | 7059 (006) Braid Web Stretch |
| 9186 (091) Oval Portriat | 7046 (006) Allover Ruffle Stretch |
| 2990 (006) Logo Square Buckle | 7048 (910) Distressed Stretch |
| 2990 (091) Logo Square Buckle | 7048 (006) Distressed Stretch |
| 8163 (006) Adjust Hook Belt | 7048 (816) Distressed Stretch |
| 8163 (816) Adjust Hook Belt | 7057 (816) Braided Front Stretch |
| 7052 (016) Super Wide | 7057 (006) Braided Front Stretch |
| 7051 (947) Super Wide | |
| 7051 (006) Super Wide | |
| 7025 (016) Laced Grommets Belt | |
| 7025 (816) Laced Grommets Belt | |

The Following styles can also be housed on this fixture
 7026 (939) Belted Safari
 7049 (006) Multi Ring Stretch